

Your Company  
Address

Customer	Job Site
Texas Children's Pediatric	
<b>Item Description</b>	
CPT: J&J - Impulse III / Tell A Tale 1811 - Straight Lay 24" x 24" SY	
RF1: Tarkett - Color Play - Color Beam / Caramel C117 6" x 36" SF	
RF2: Tarkett - Color Play - Color Beam / Cerulean C103 6" x 36" SF	
RF3: Tarkett - Color Play - Color Beam / Goldenrod C107 6" x 36" SF	
RB1: Roppe - Cove / P175 Slate 4" LF	
RB1: Roppe - Straight / P175 Slate 4" LF	
Resilient / Carpet : Supplier - Style / Color - All TBD 0" LF	
T1: Trinity Tile - Social Collection / White Shades: Horizontal Install 12" x 24" SF	
T1: Floors SF	
T1: Walls SF	
T2: Trinity Tile - Social Collection / Balance Grey 12" x 24" SF	
T3: Daltile - Color Wave / Russet Orange CW29 3" x 6" SF	
T4: Daltile - Color Wave / Purple Magic CW31 3" x 6" SF	
T5: Daltile - Color Wave / Capri Breeze CW32 3" x 6" SF	
Grout: Laticrete / 18 Sauterne SF	
Schluter: Dilex - TBD / Color TBD SF	
Dilex: LF 0" LF	
Dilex: Connectors EA	
Dilex: IC EA	
Dilex: OC EA	
Crack Suppression SF	
Thinset SF	
Waterproofing SF	
Threshold: Supplier - Style / Color: Thickness 0" LF	
Exposed Edges: Schluter: Quadec Trendline / Color TBD 0" LF	
Project Size SF	



## GENERAL FINISH PLAN NOTES

1. REFER TO THE ROOM FINISH SCHEDULE SHEET ASX FOR ALL FINISH DESIGNATIONS. FINISH PLANS TO BE USED WHEN MORE THAN ONE FINISH IS USED IN A ROOM.
2. REFER TO A11 SERIES FOR INTERIOR ELEVATIONS
3. PT1 AT ALL WALLS U.N.O.

## KEYNOTE LEGEND

## INTERIOR FINISH LEGEND

ROOM NAME  
XXX  
#/#/#/#

COMMENT  
WALL  
BASE  
FLOOR

XXX ← ROOM NAME  
-- ← ROOM #  
-- ← FLOOR FINISH  
-- ← BASE FINISH  
-- ← WALL FINISH  
-- ← ROOM FINISH COMMENT

ALIGN → ALIGN FINISH  
→ GRAIN DIRECTION  
┌ ┘ CORNER, END GUARD  
-XX- EXTENTS OF FINISH  
✕ CHANGE IN FLOORING TYPE - TRANSITION NEEDED

REFER TO FINISH PLAN / FINISH TAG

	RF1
	RF2
	RF3
	CPT1
	T1

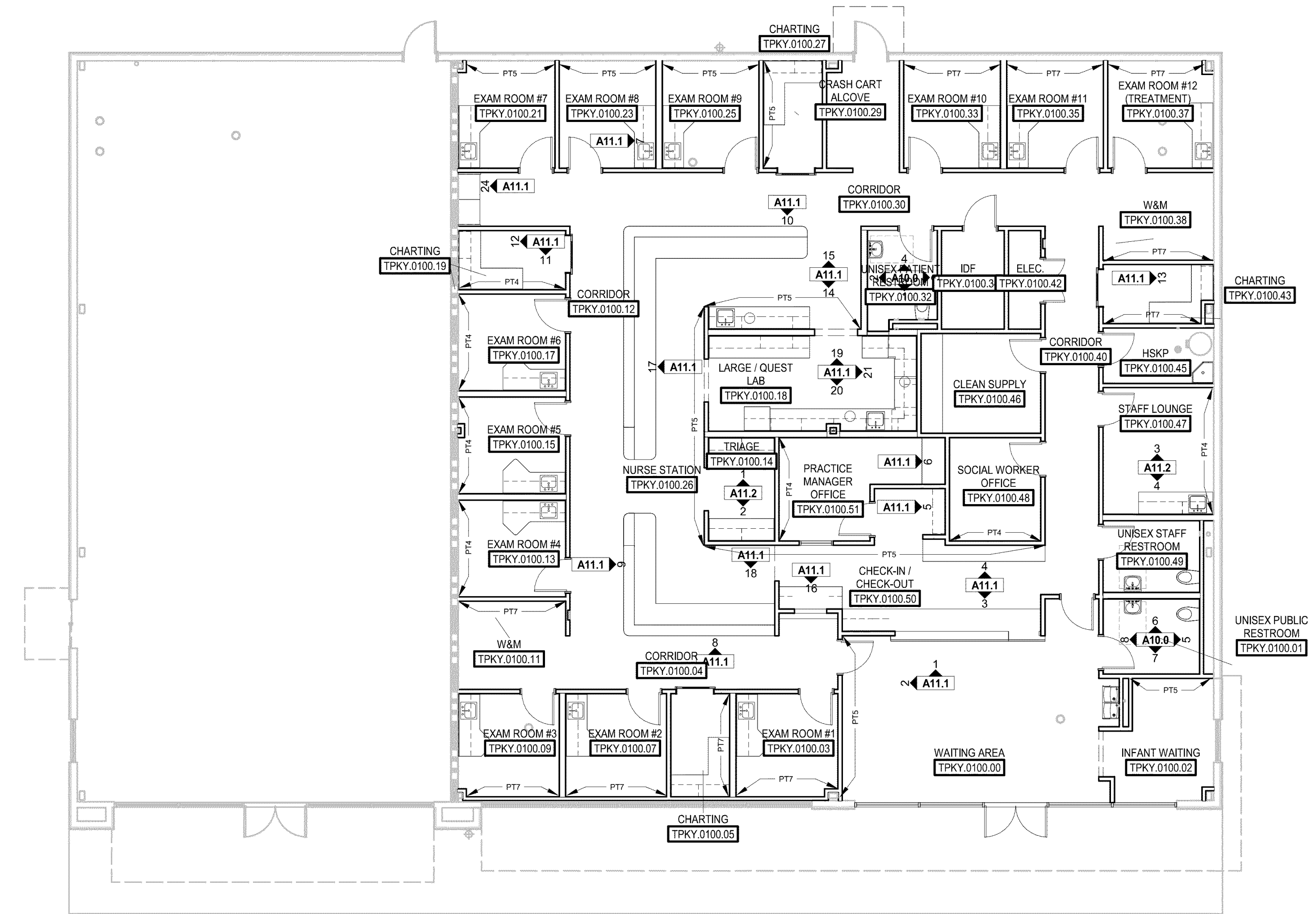

2 FIRST FLOOR WALL FINISH PLAN  
SCALE: 1/8" = 1'-0"

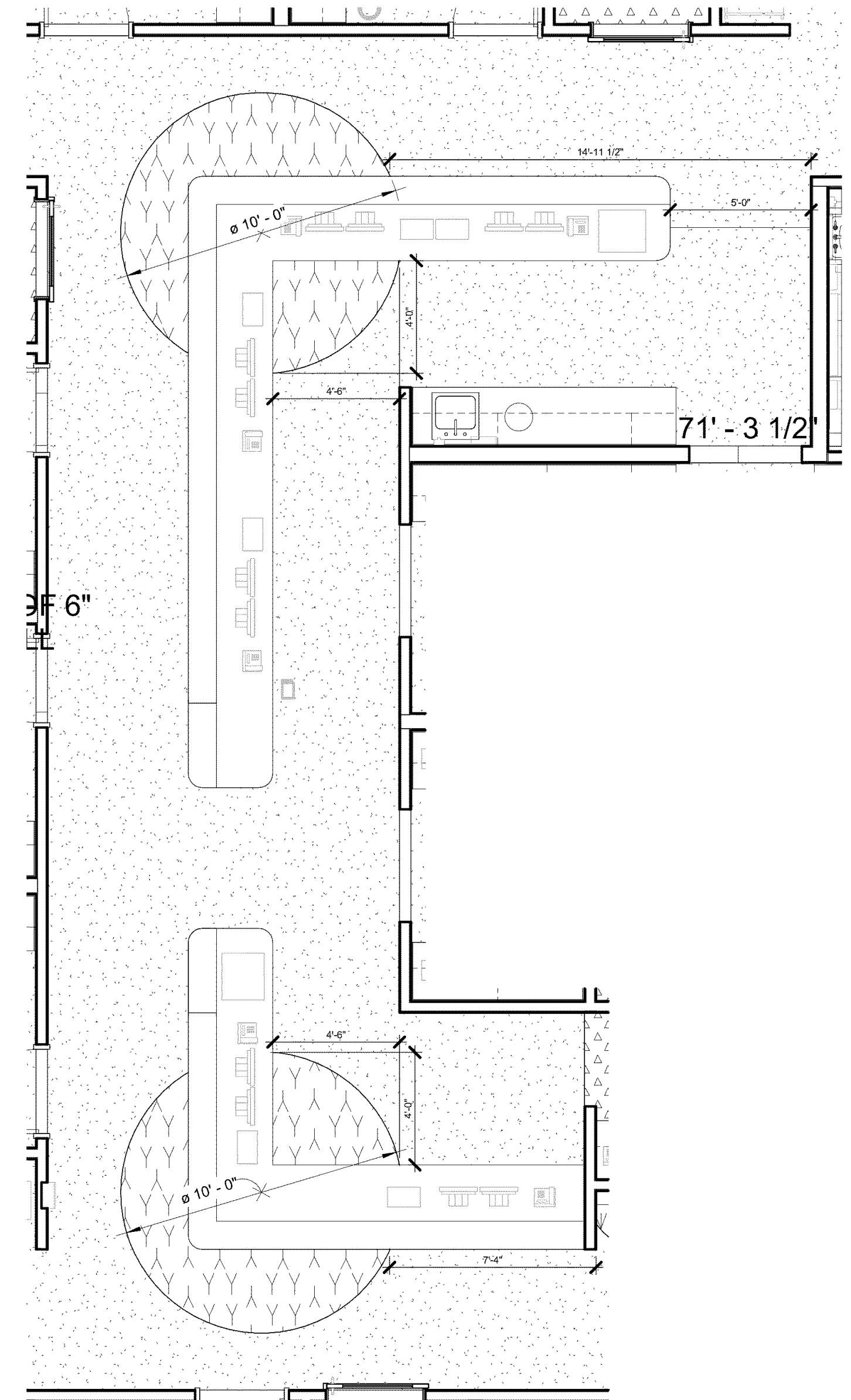

3 NURSE STATION ENLARGED FINISH PLAN  
SCALE: 1/4" = 1'-0"

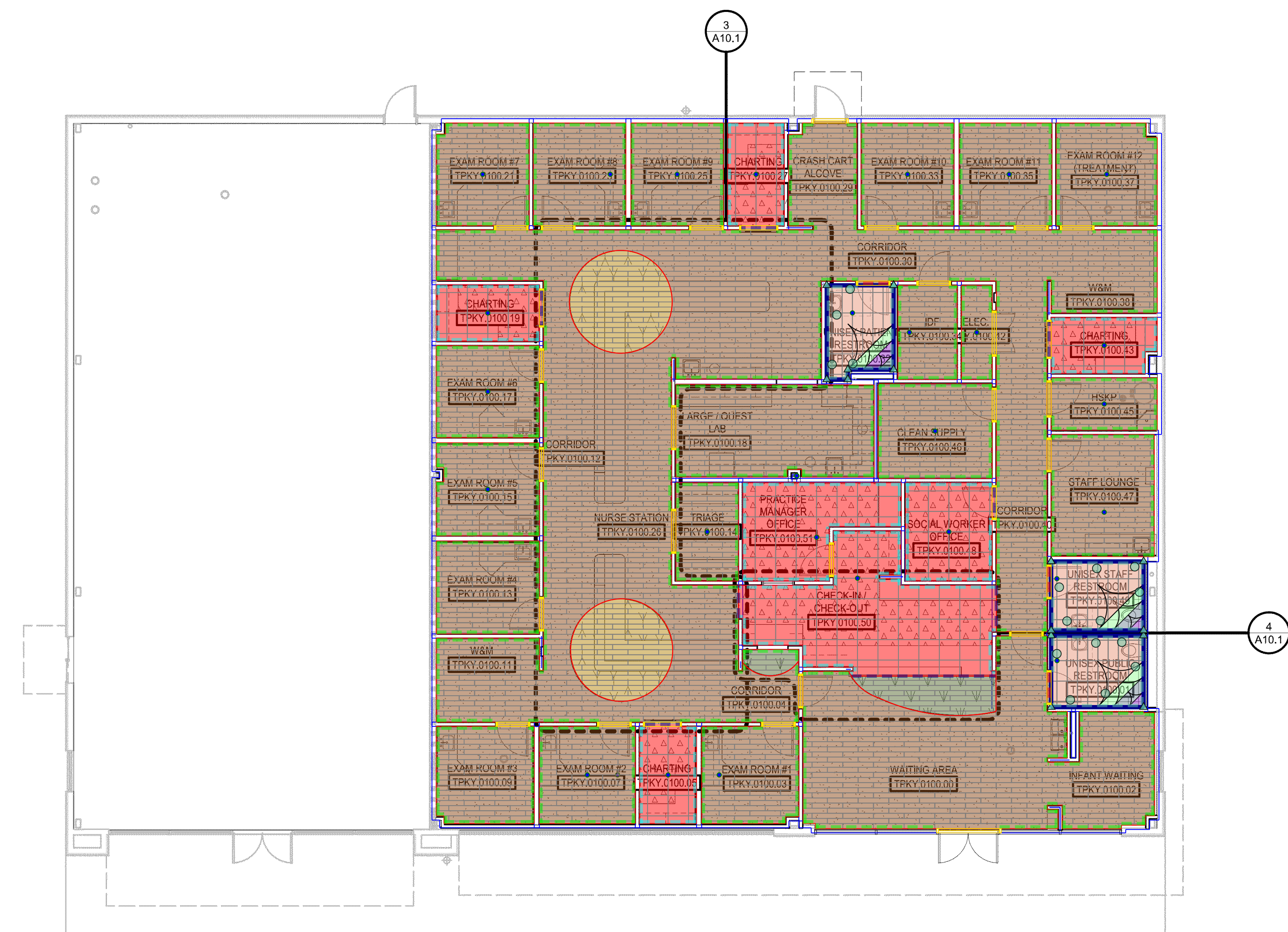

1 FIRST FLOOR FINISH PLAN  
SCALE: 1/8" = 1'-0"

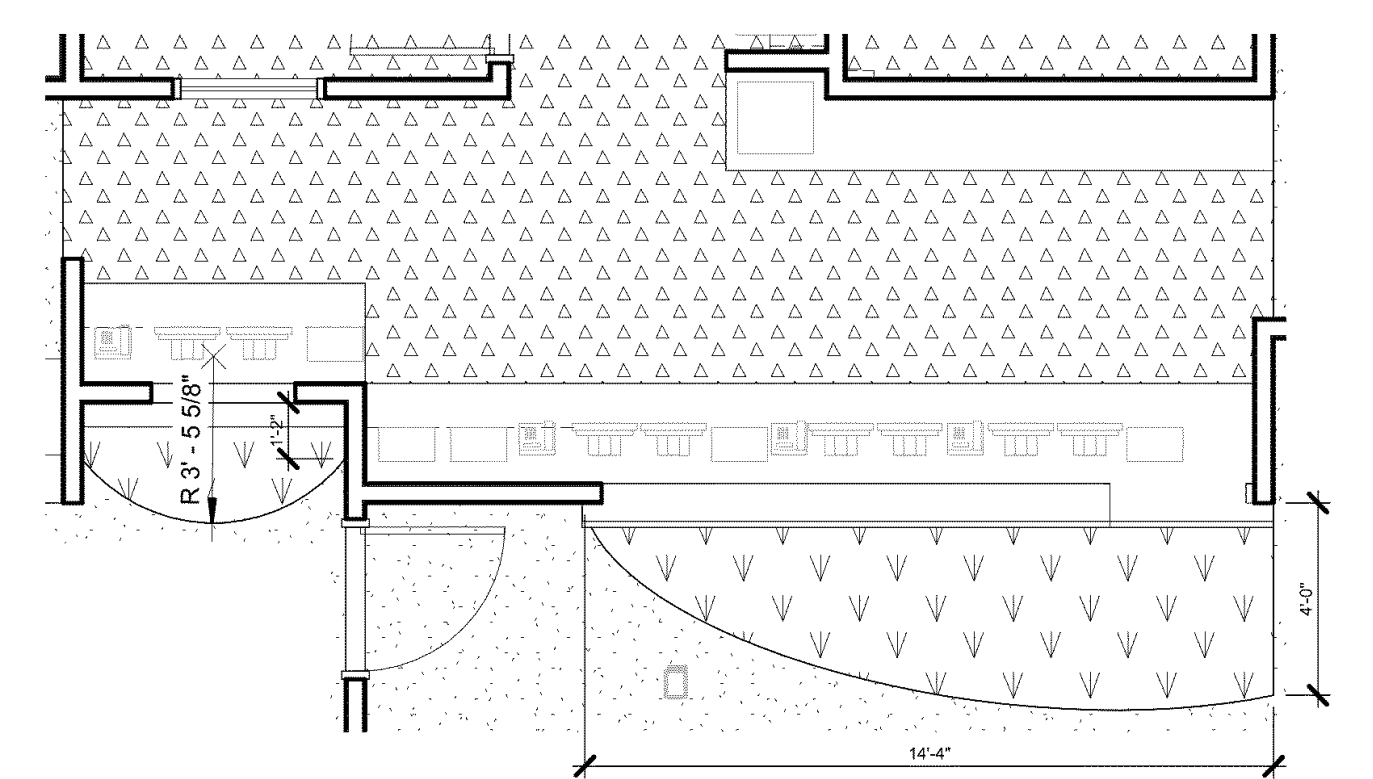

4 CHECK IN / CHECK OUT ENLARGED FINISH PLAN  
SCALE: 1/4" = 1'-0"

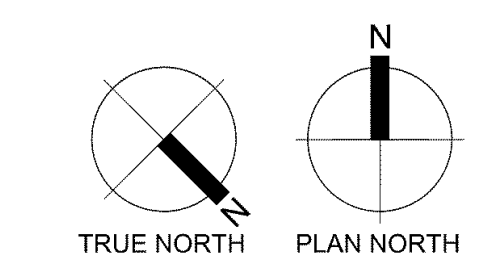



- nisex - TPKY.0100.32
- T1: Trinity Tile - Social Collection / White Shades: Horizontal Install 12" x 24" SF
- T1: Floors SF
- T1: Walls SF
- T2: Trinity Tile - Social Collection / Balance Grey 12" x 24" SF
- T3: Daltile - Color Wave / Russet Orange CW29 3" x 6" SF
- T4: Daltile - Color Wave / Purple Magic CW31 3" x 6" SF
- T5: Daltile - Color Wave / Capri Breeze CW32 3" x 6" SF
- Grout: Laticrete / 18 Sauterne SF
- Schluter: Dillex - TBD / Color TBD SF
- Dillex: LF 0" LF
- Dillex: Connectors EA
- Dillex: IC EA
- Dillex: OC EA
- Crack Suppression SF
- Thinset SF
- Threshold: Supplier - Style / Color: Thickness 0" LF
- Exposed Edges: Schluter: Quadec Trendline / Color TBD 0" LF
- Project Size SF

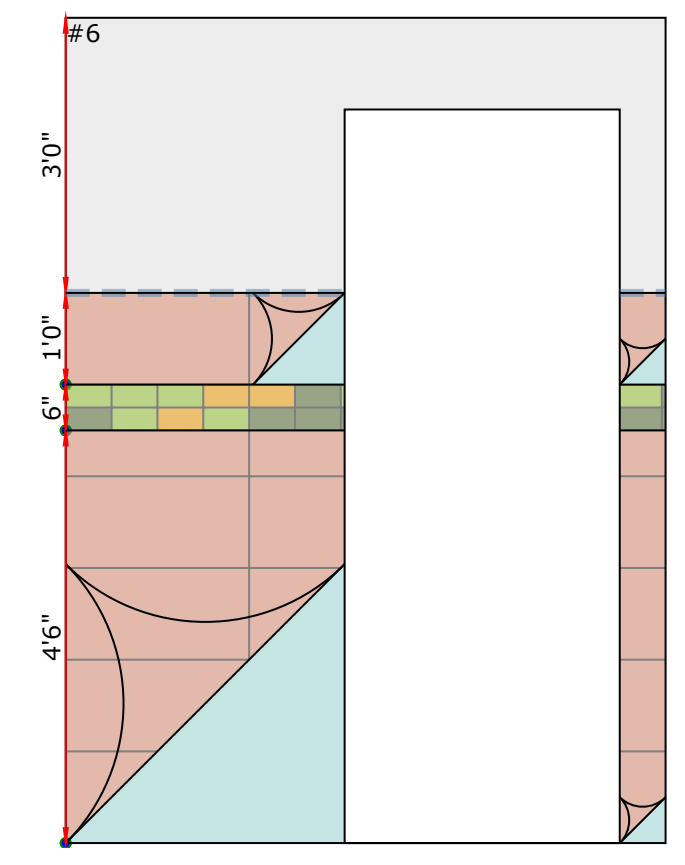
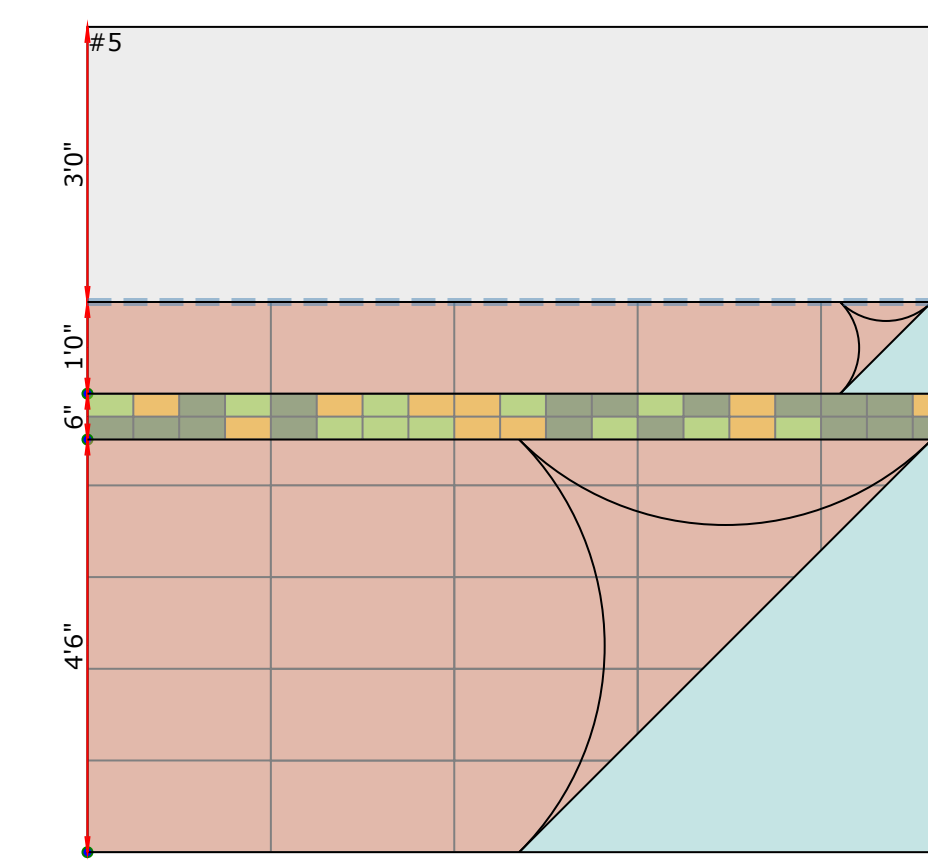
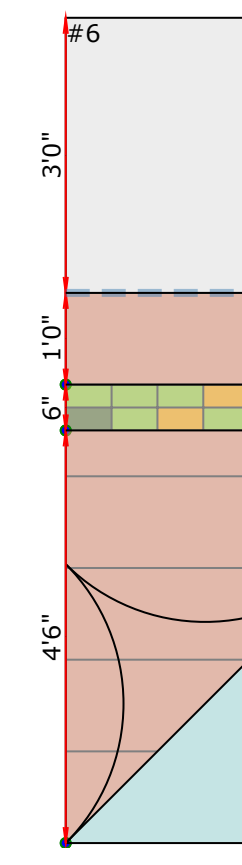
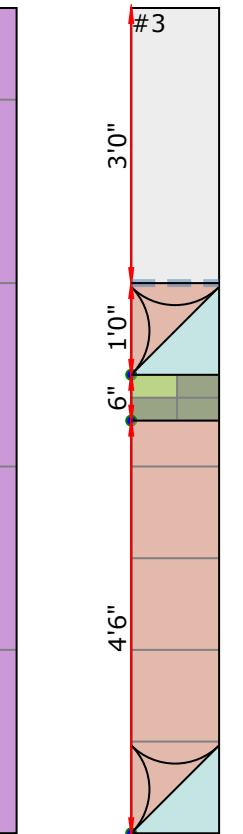
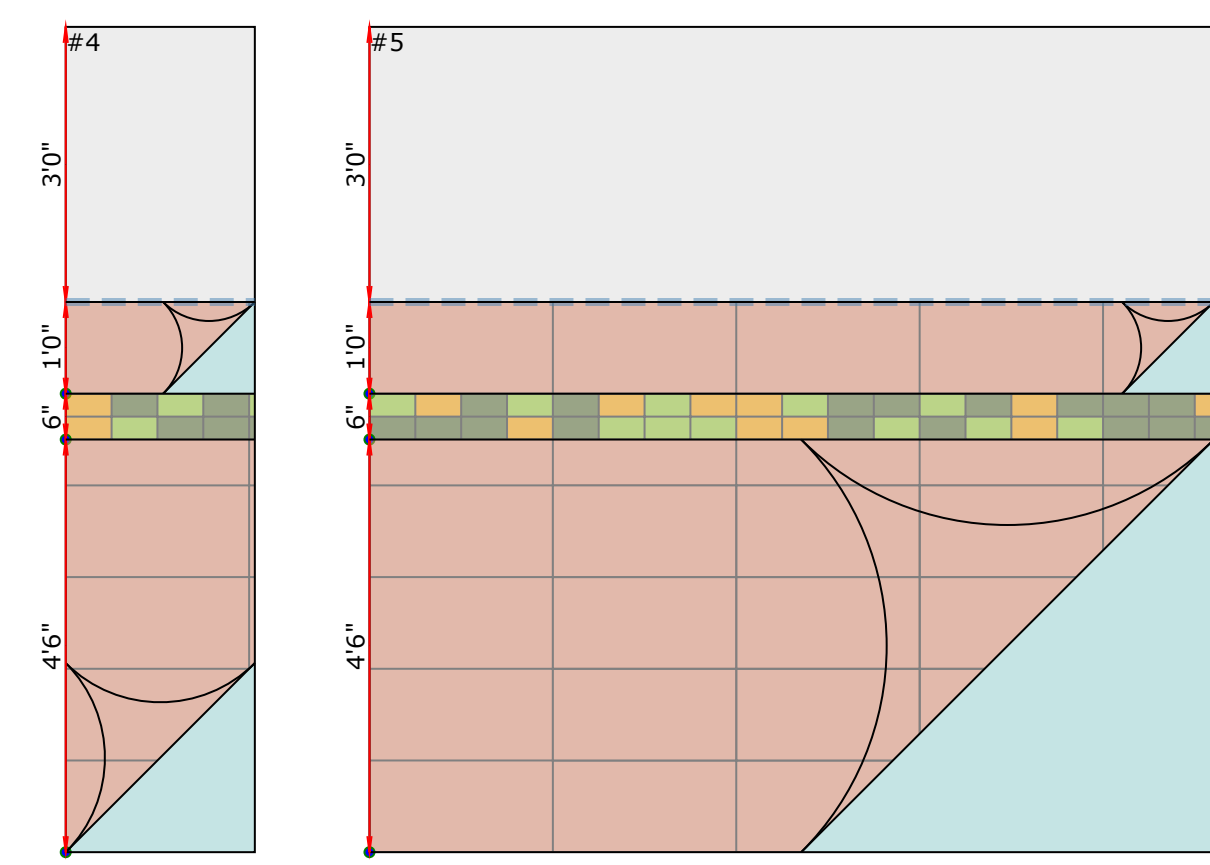
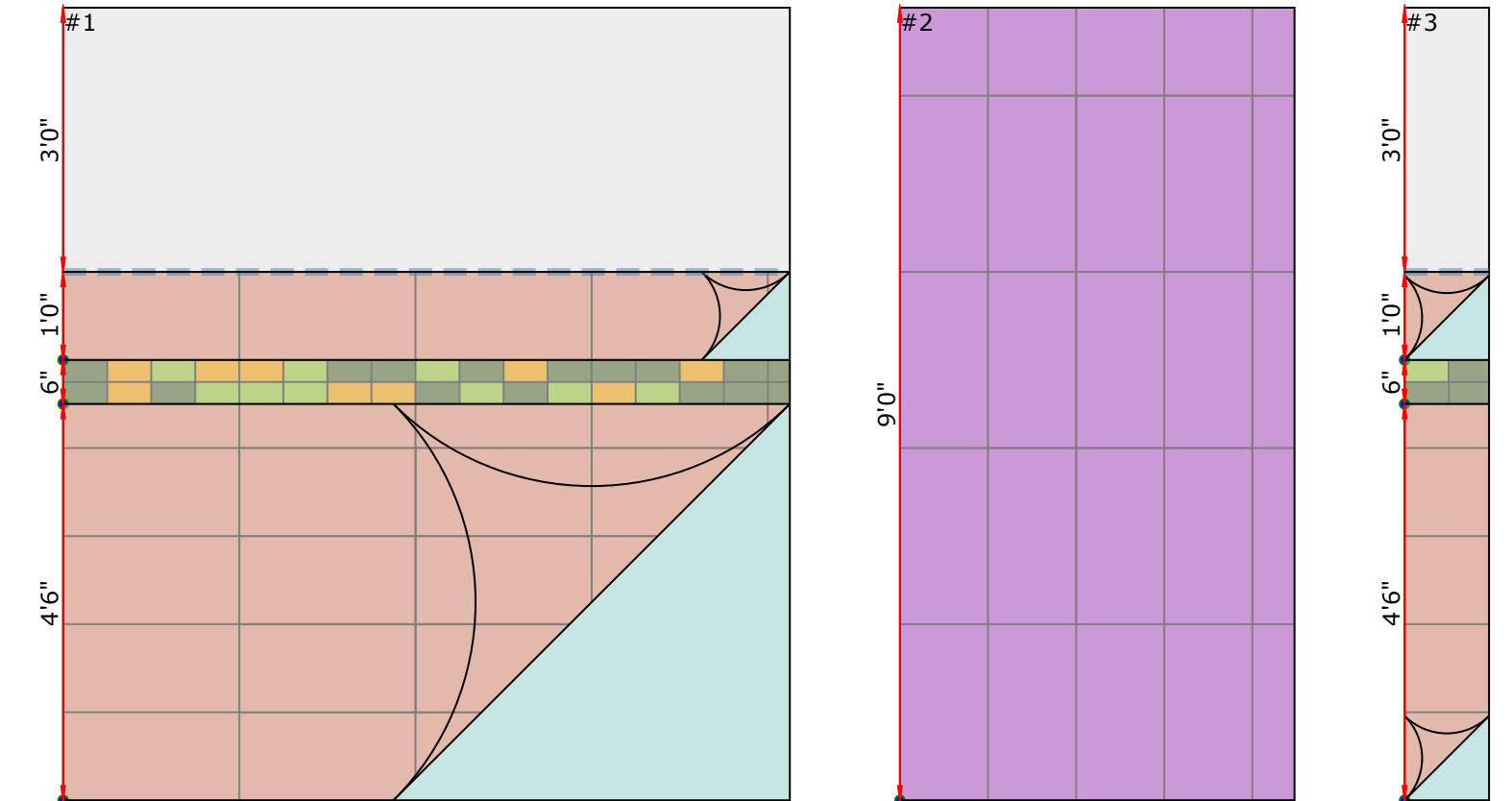
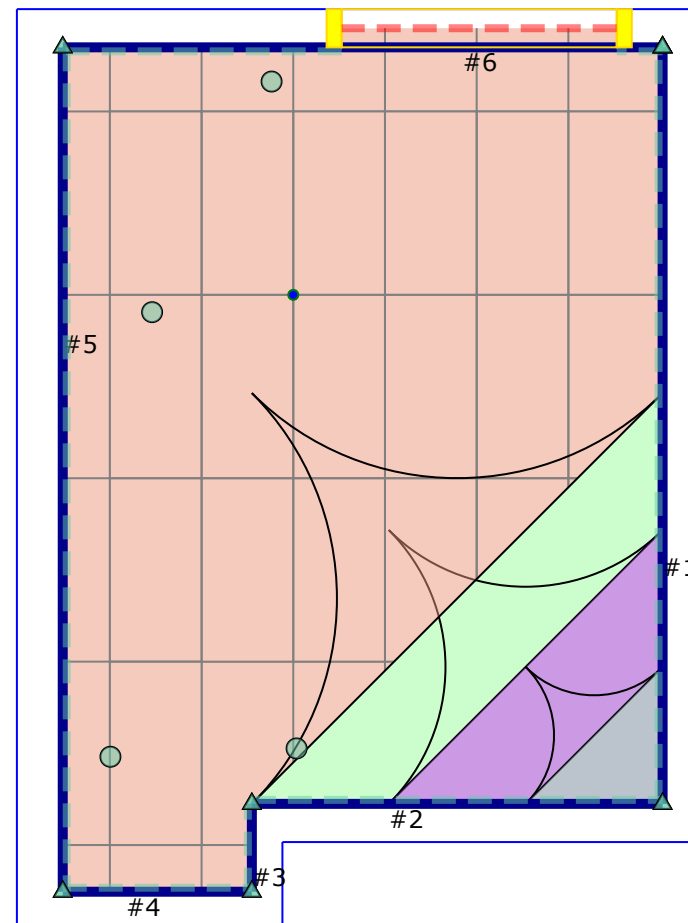

- nisex - TPKY,0100,01
- T1: Trinity Tile - Social Collection / White Shades: Horizontal Install 12" x 24" SF
- T1: Floors SF
- T1: Walls SF
- T2: Trinity Tile - Social Collection / Balance Grey 12" x 24" SF
- T3: Daltile - Color Wave / Russet Orange CW29 3" x 6" SF
- T4: Daltile - Color Wave / Purple Magic CW31 3" x 6" SF
- T5: Daltile - Color Wave / Capri Breeze CW32 3" x 6" SF
- Grout: Laticrete / 18 Sauterne SF
- Schluter: Dillex - TBD / Color TBD SF
- Dillex: LF 0" LF
- Dillex: Connectors EA
- Dillex: IC EA
- Dillex: OC EA
- Crack Suppression SF
- Thinset SF
- Threshold: Supplier - Style / Color: Thickness 0" LF
- Exposed Edges: Schluter: Quadec Trendline / Color TBD 0" LF
- Project Size SF

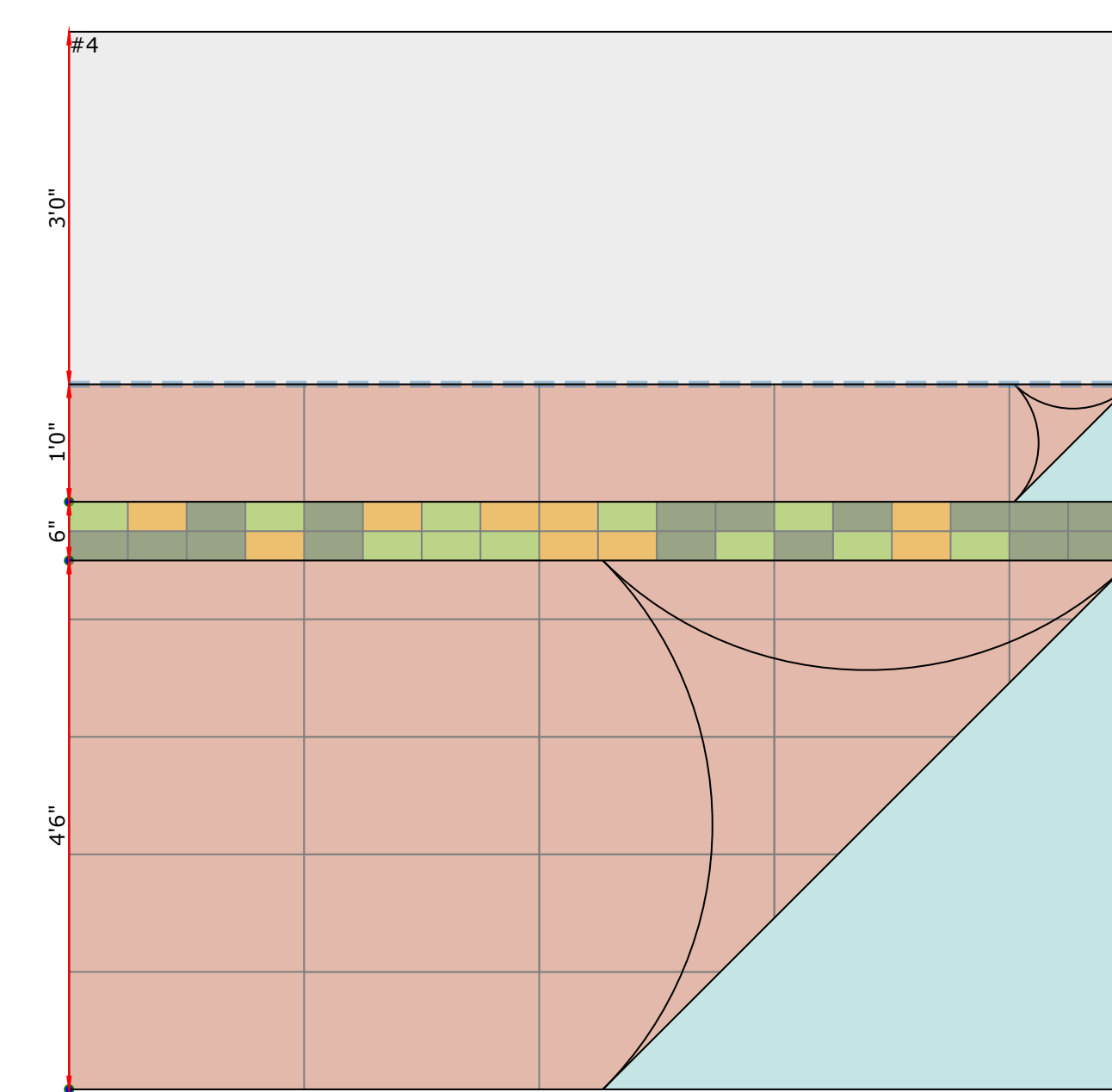
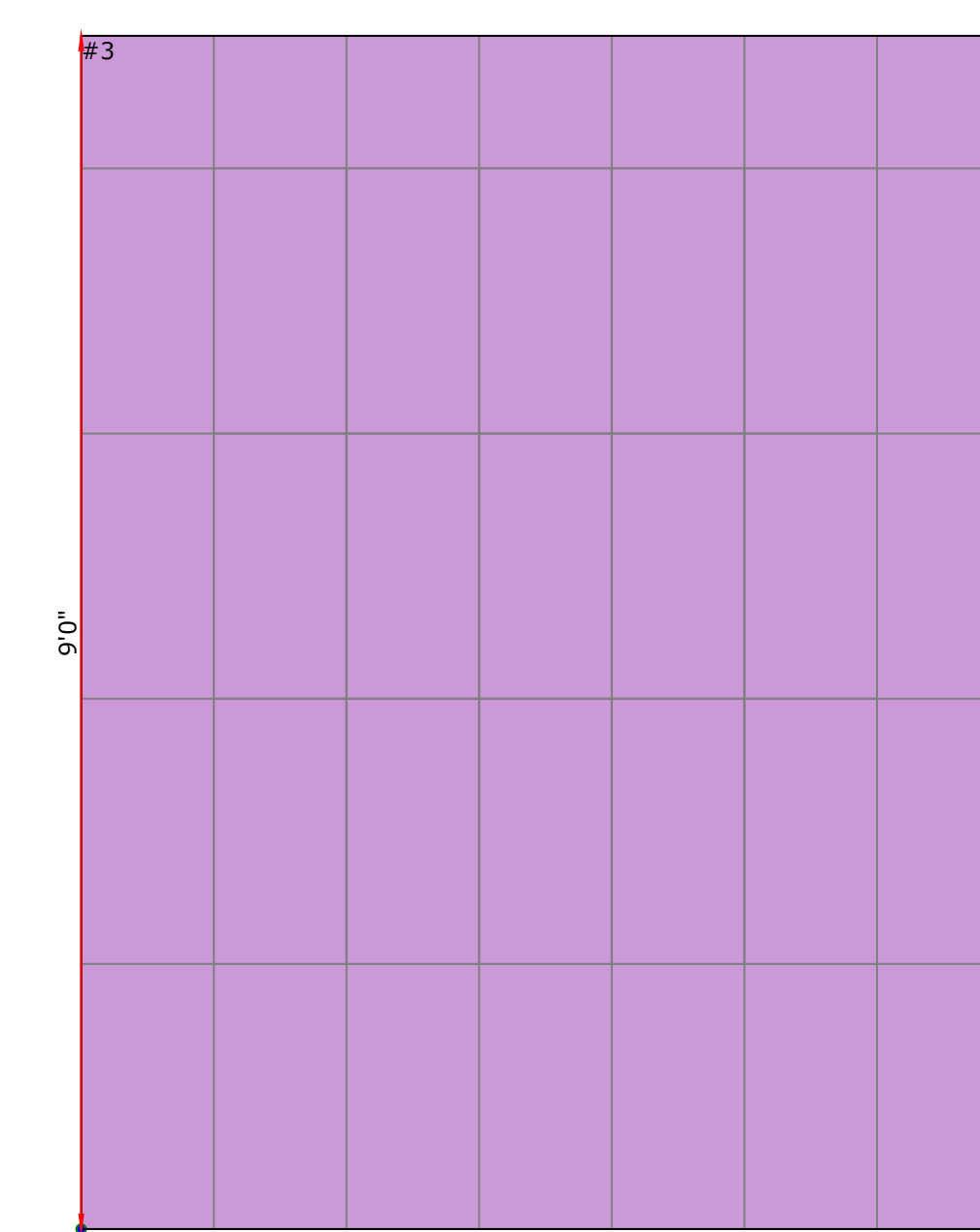
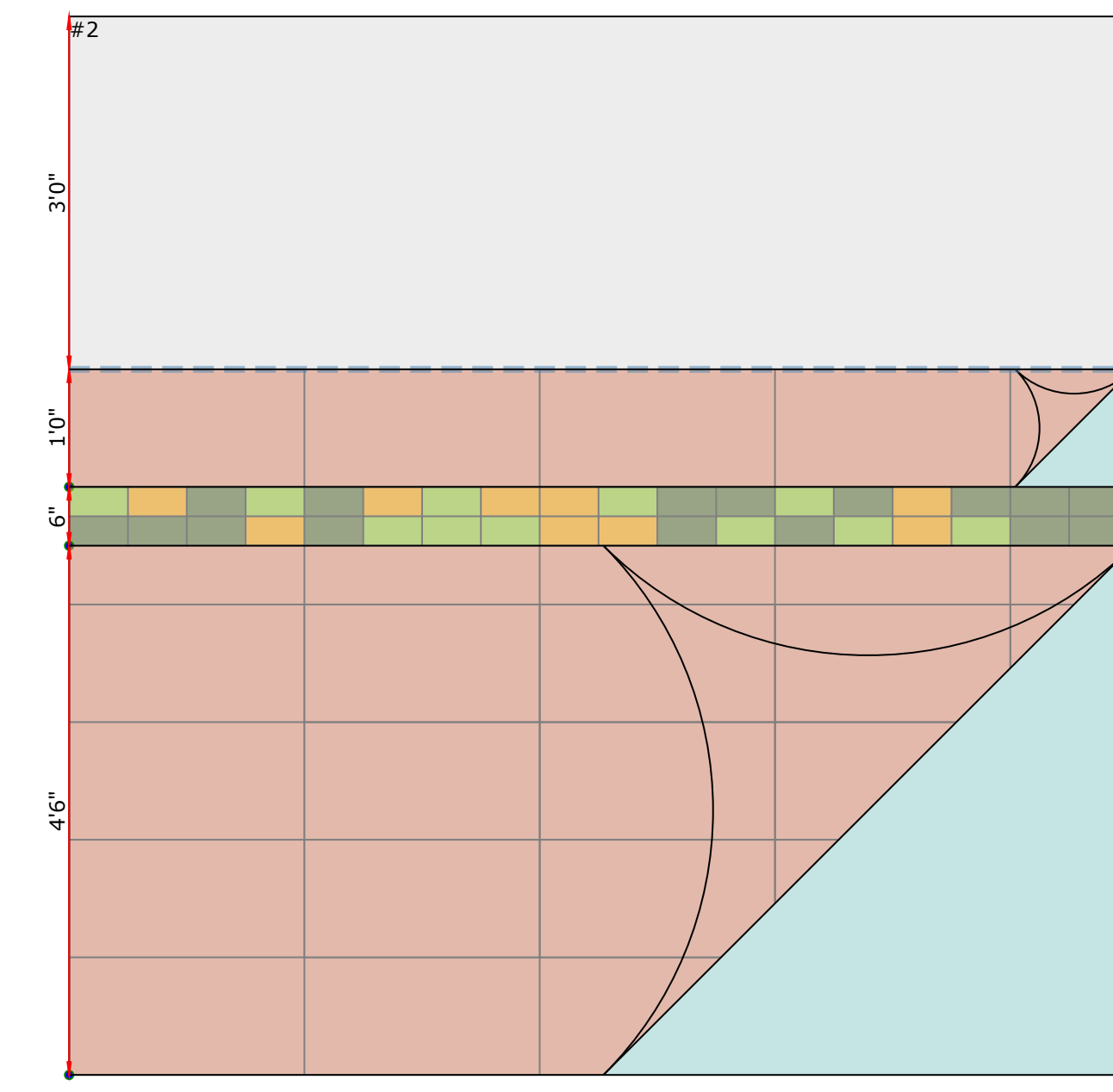
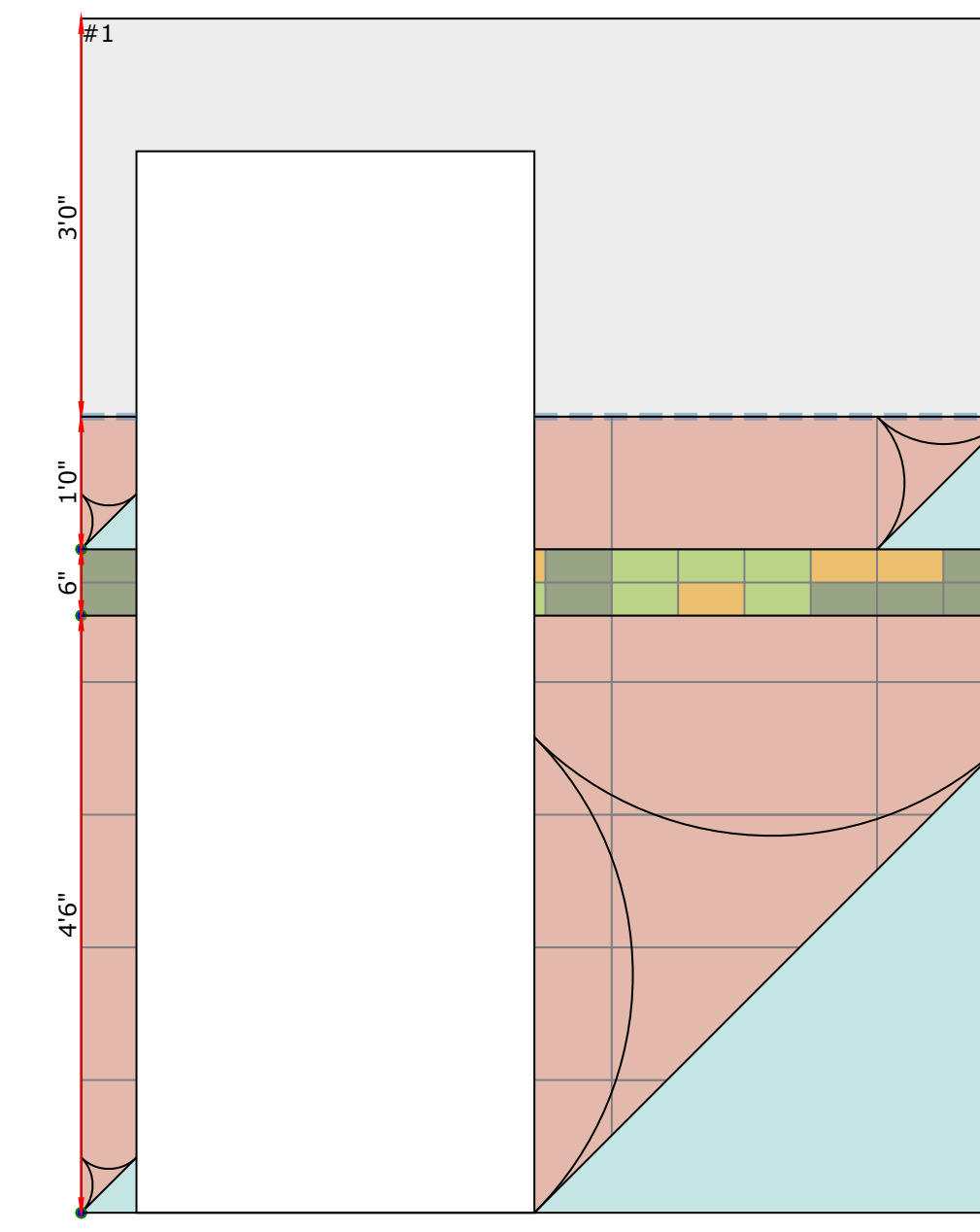
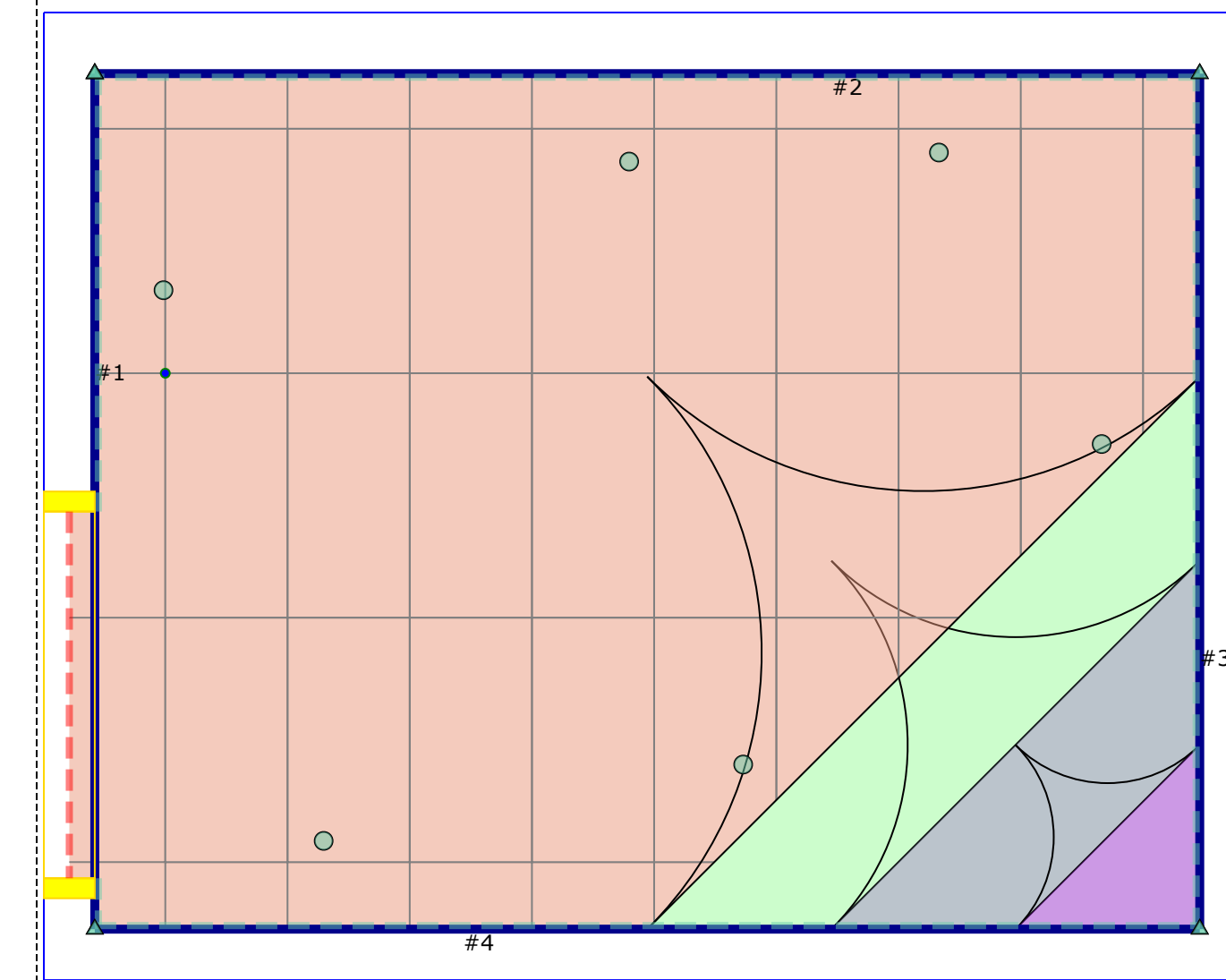

- nisex - TPKY,0100,49
- T1: Trinity Tile - Social Collection / White Shades: Horizontal Install 12" x 24" SF
- T1: Floors SF
- T1: Walls SF
- T2: Trinity Tile - Social Collection / Balance Grey 12" x 24" SF
- T3: Daltile - Color Wave / Russet Orange CW29 3" x 6" SF
- T4: Daltile - Color Wave / Purple Magic CW31 3" x 6" SF
- T5: Daltile - Color Wave / Capri Breeze CW32 3" x 6" SF
- Grout: Laticrete / 18 Sauterne SF
- Schluter: Dillex - TBD / Color TBD SF
- Dillex: LF 0" LF
- Dillex: Connectors EA
- Dillex: IC EA
- Dillex: OC EA
- Crack Suppression SF
- Thinset SF
- Threshold: Supplier - Style / Color: Thickness 0" LF
- Exposed Edges: Schluter: Quadec Trendline / Color TBD 0" LF
- Project Size SF

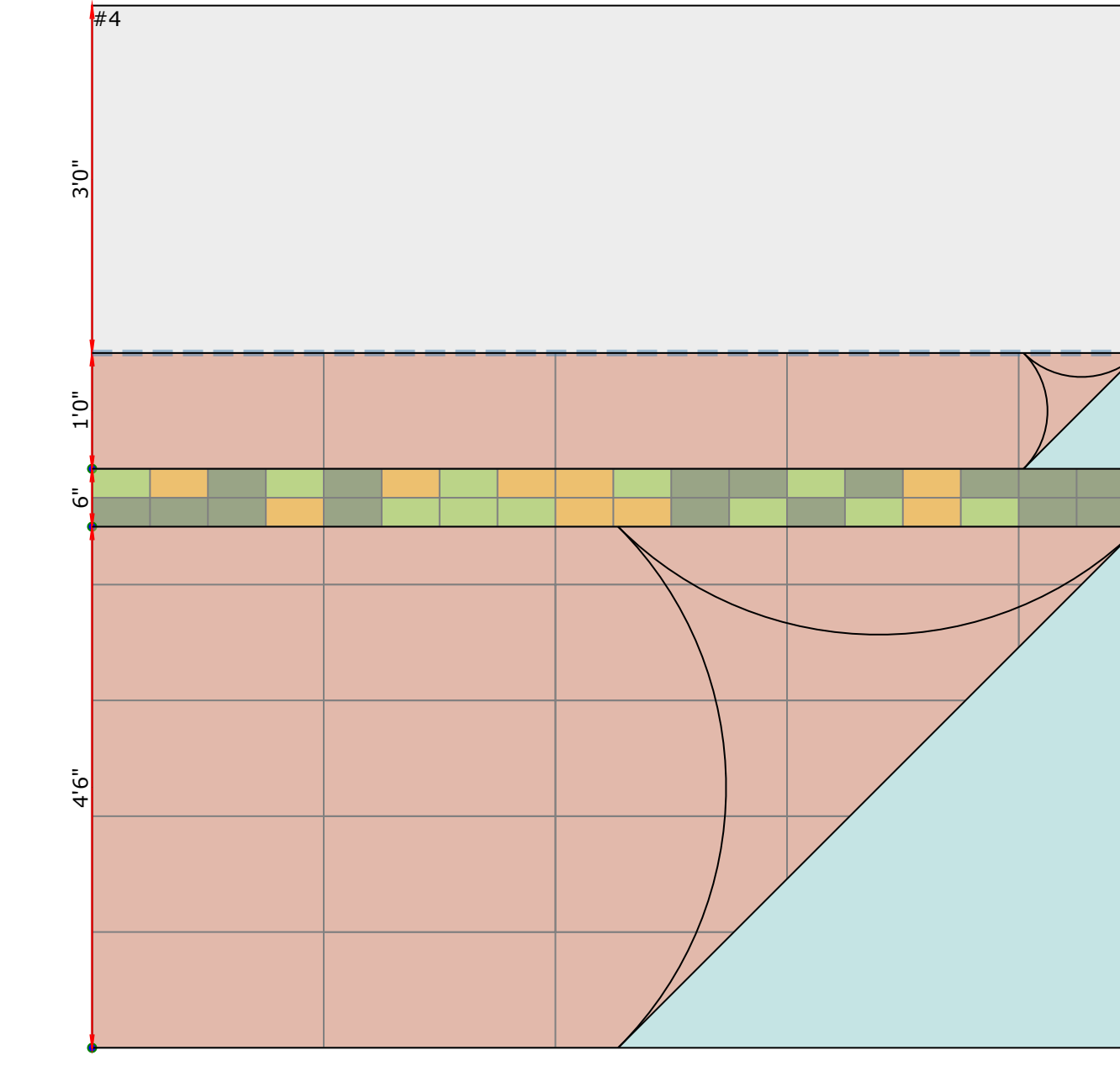
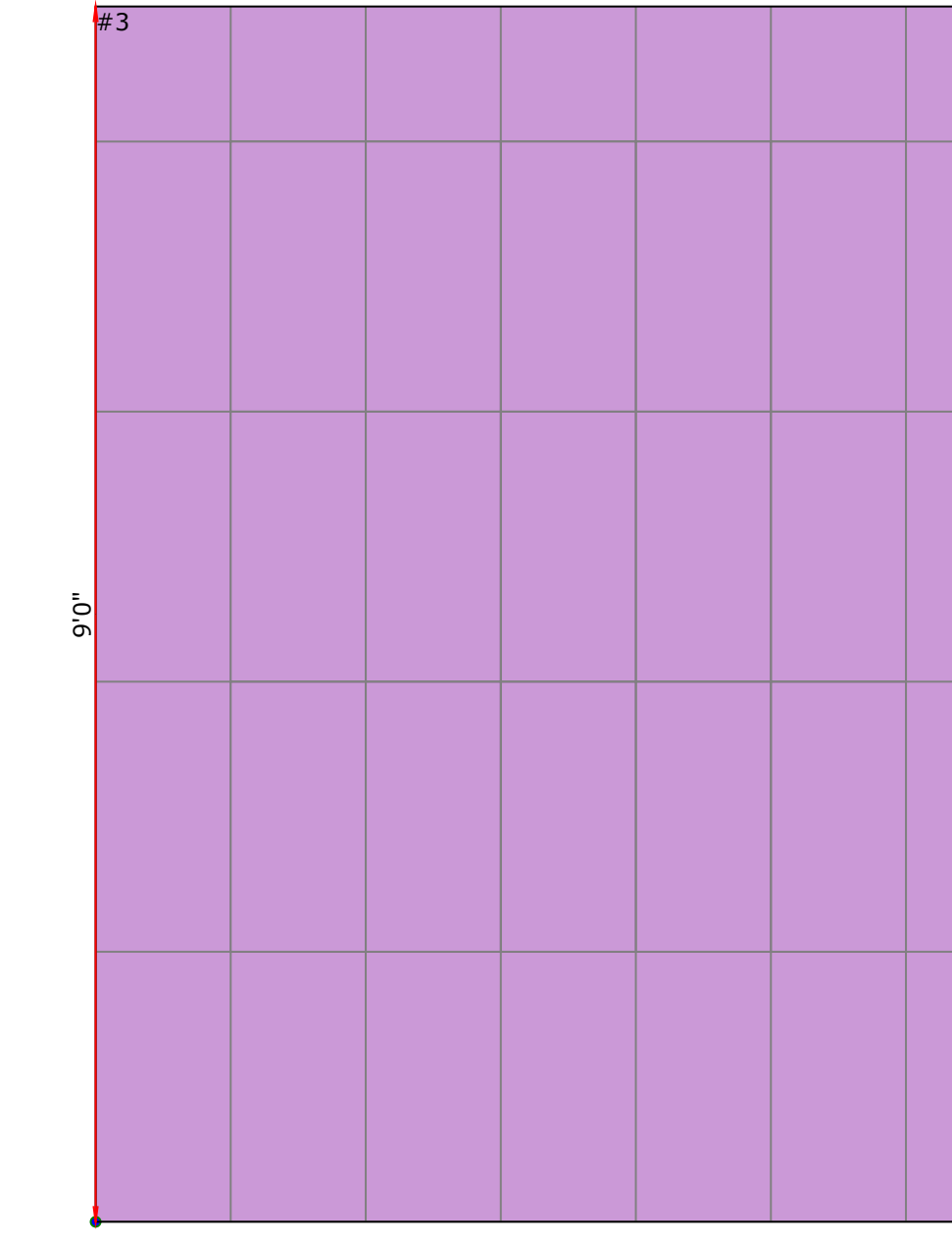
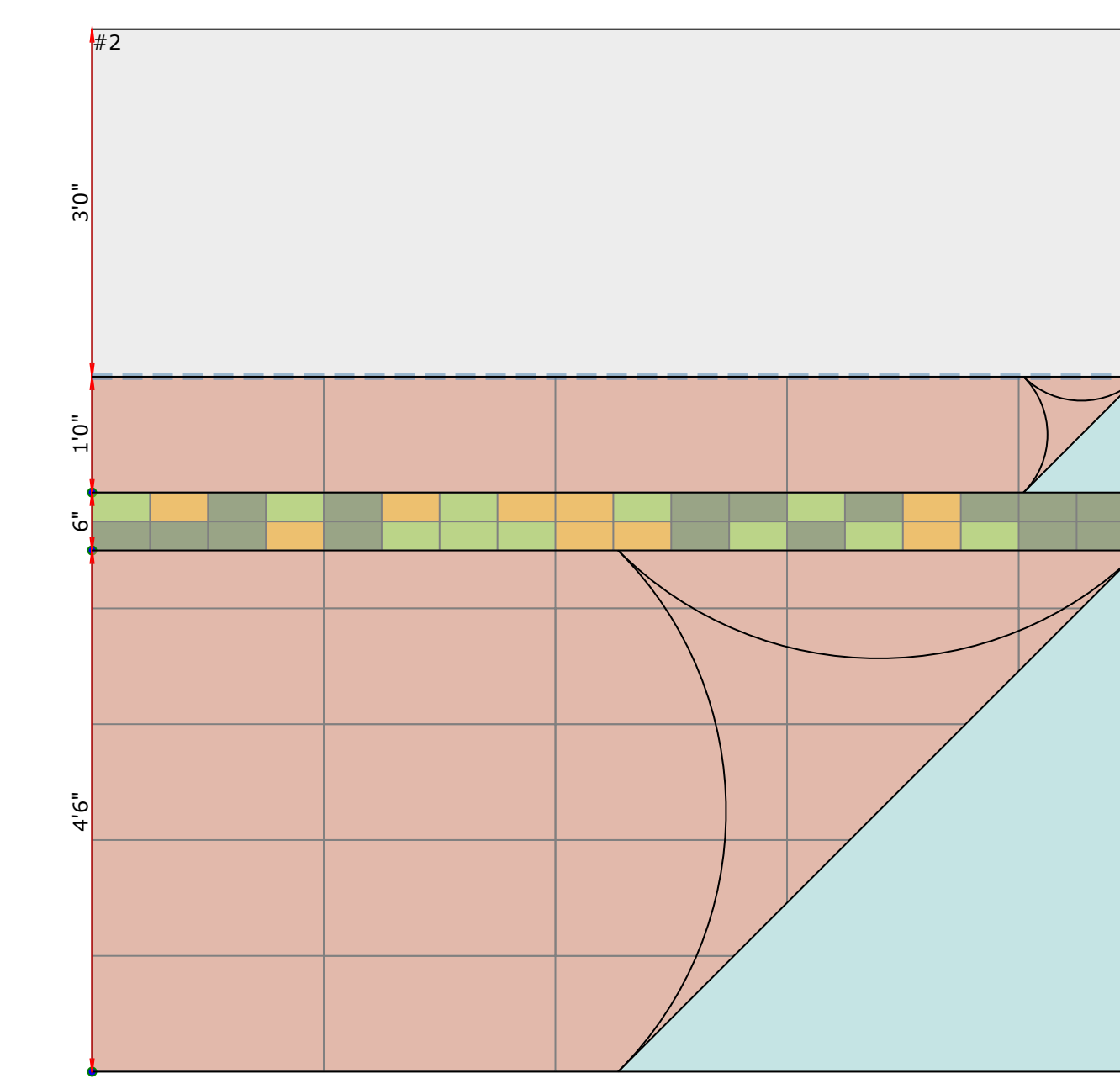
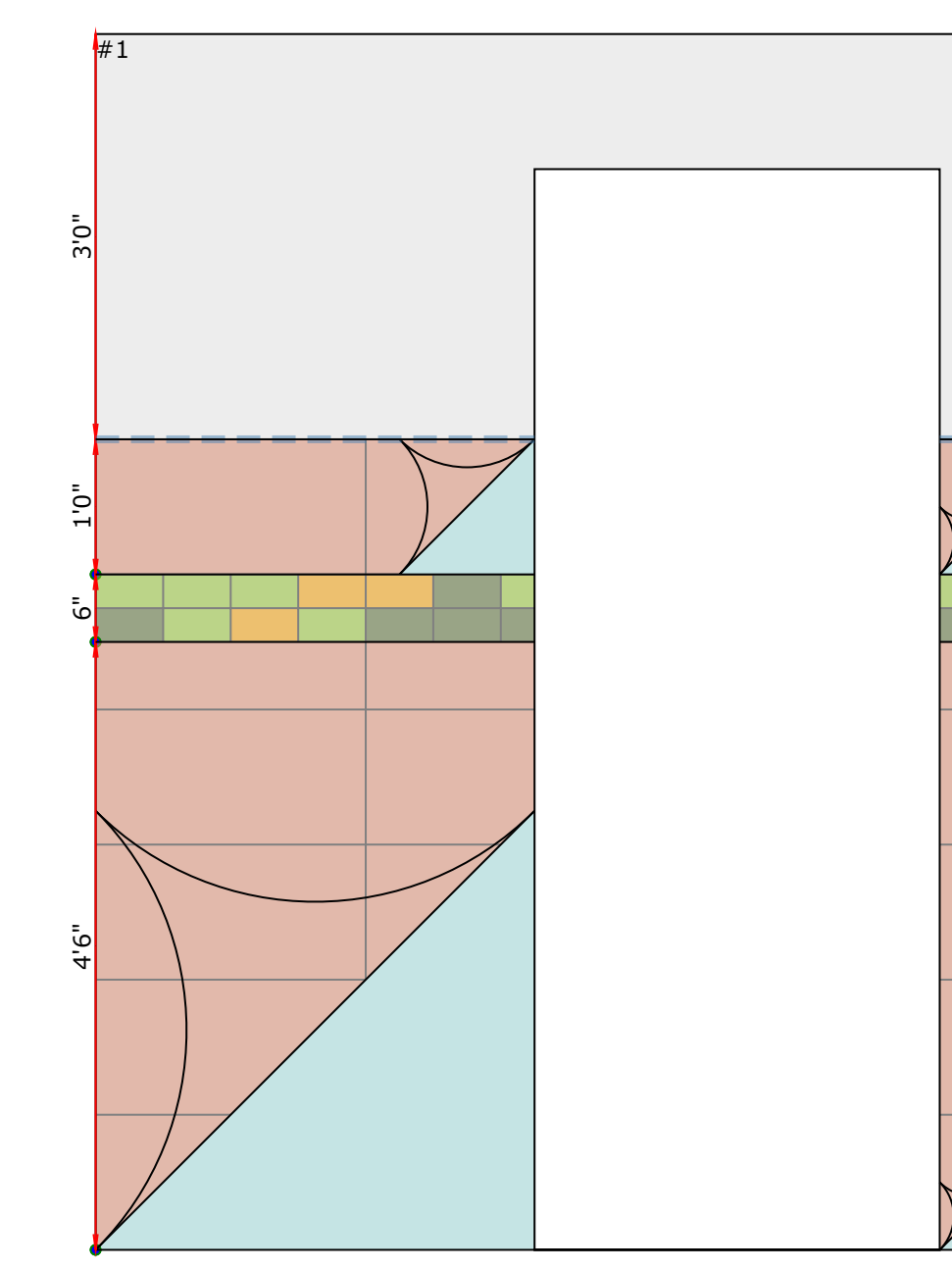
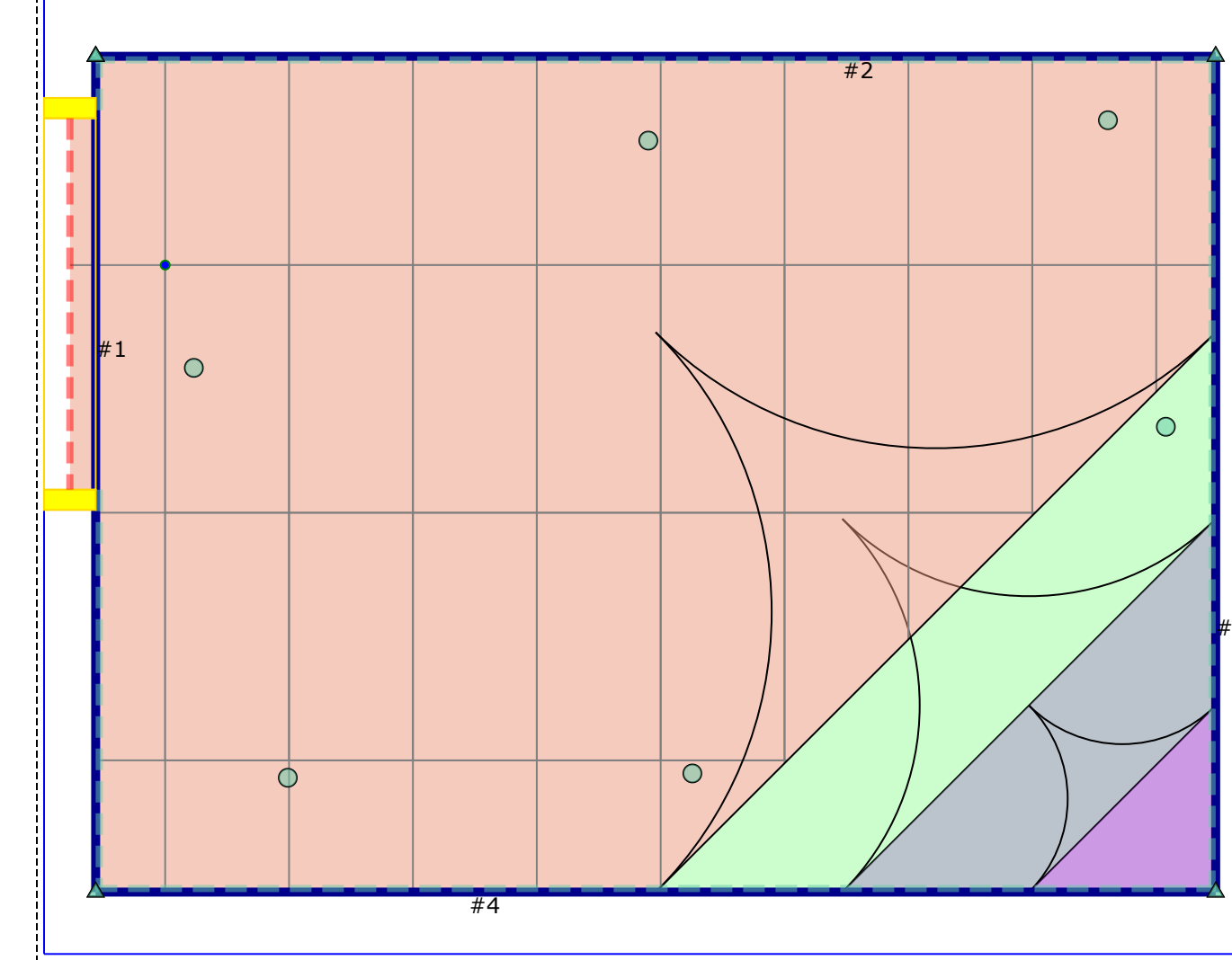



## GENERAL FINISH PLAN NOTES

1. REFER TO THE ROOM FINISH SCHEDULE SHEET ASX FOR ALL FINISH DESIGNATIONS. FINISH PLANS TO BE USED WHEN MORE THAN ONE FINISH IS USED IN A ROOM.
2. REFER TO A11 SERIES FOR INTERIOR ELEVATIONS
3. PT1 AT ALL WALLS U.N.O.

## KEYNOTE LEGEND

## INTERIOR FINISH LEGEND

ROOM NAME  
XXX  
#/#/#/#

COMMENT  
WALL  
BASE  
FLOOR

XXX ← ROOM NAME  
-- ← ROOM #  
-- ← FLOOR FINISH  
-- ← BASE FINISH  
-- ← WALL FINISH  
-- ← ROOM FINISH COMMENT

ALIGN → ALIGN FINISH  
→ → GRAIN DIRECTION  
┌ ┘ CORNER, END GUARD  
- - - - - EXTENTS OF FINISH  
X CHANGE IN FLOORING TYPE - TRANSITION NEEDED

REFER TO FINISH PLAN / FINISH TAG

	RF1
	RF2
	RF3
	CPT1
	T1

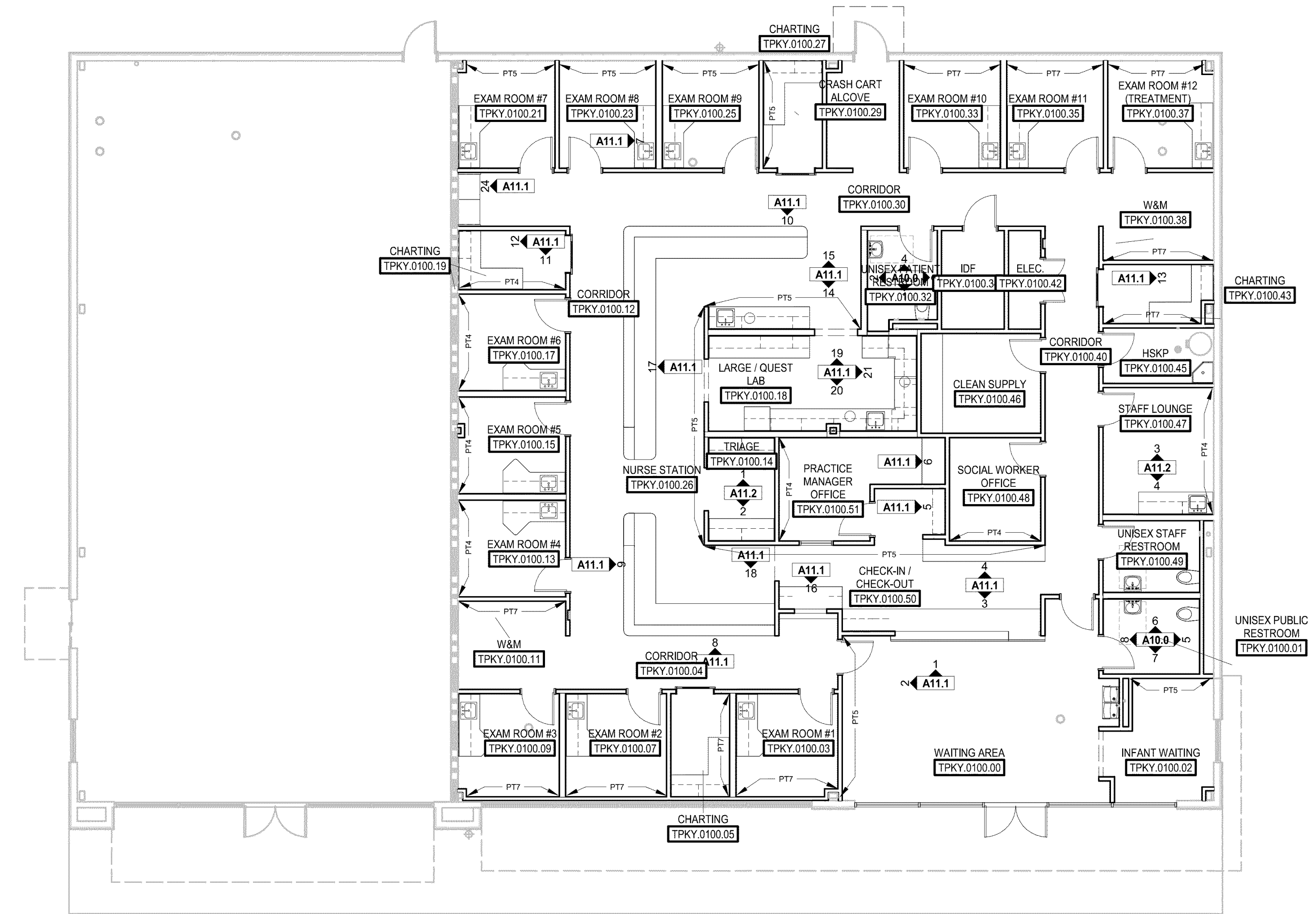

2 FIRST FLOOR WALL FINISH PLAN  
SCALE: 1/8" = 1'-0"

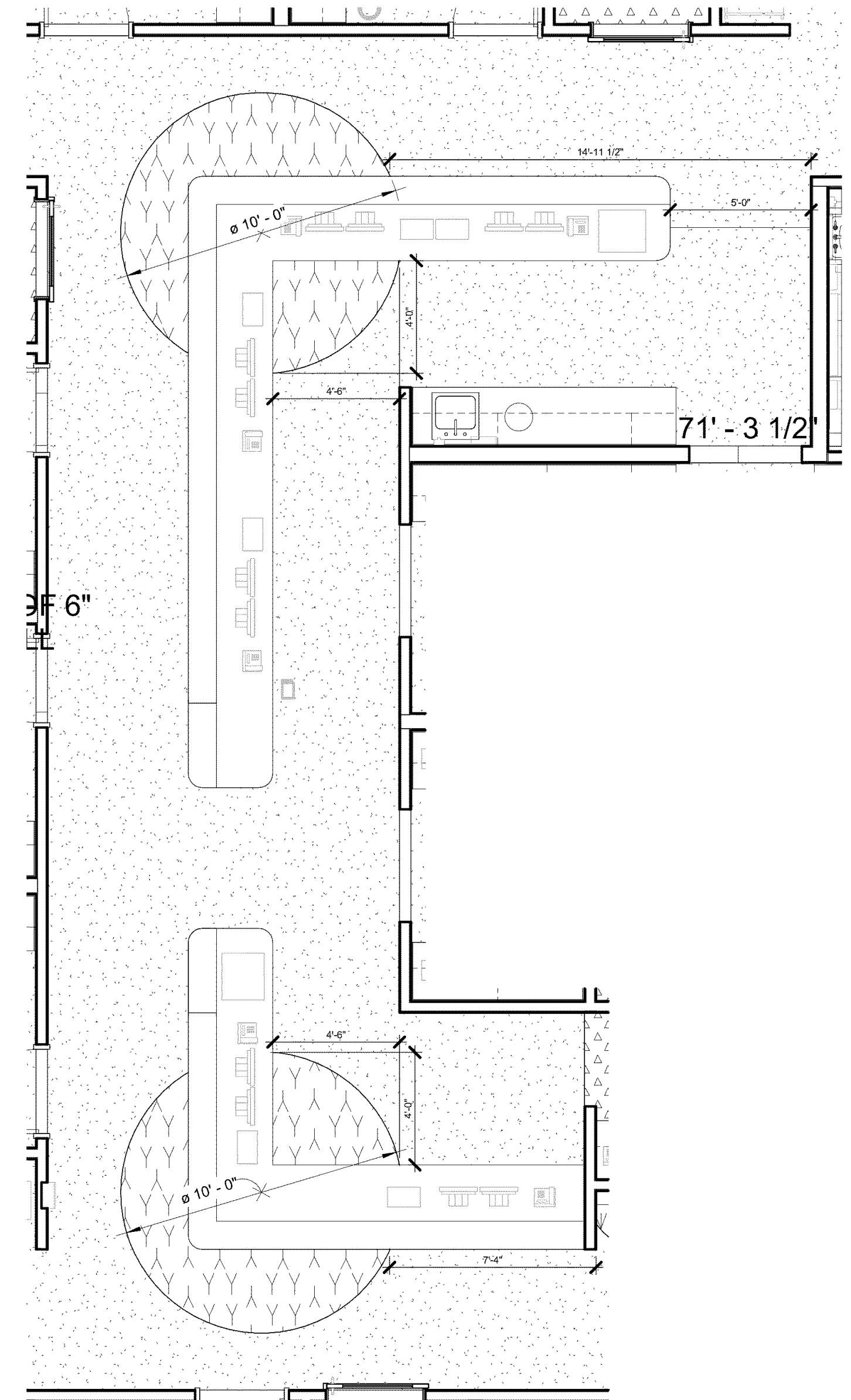

3 NURSE STATION ENLARGED FINISH PLAN  
SCALE: 1/4" = 1'-0"

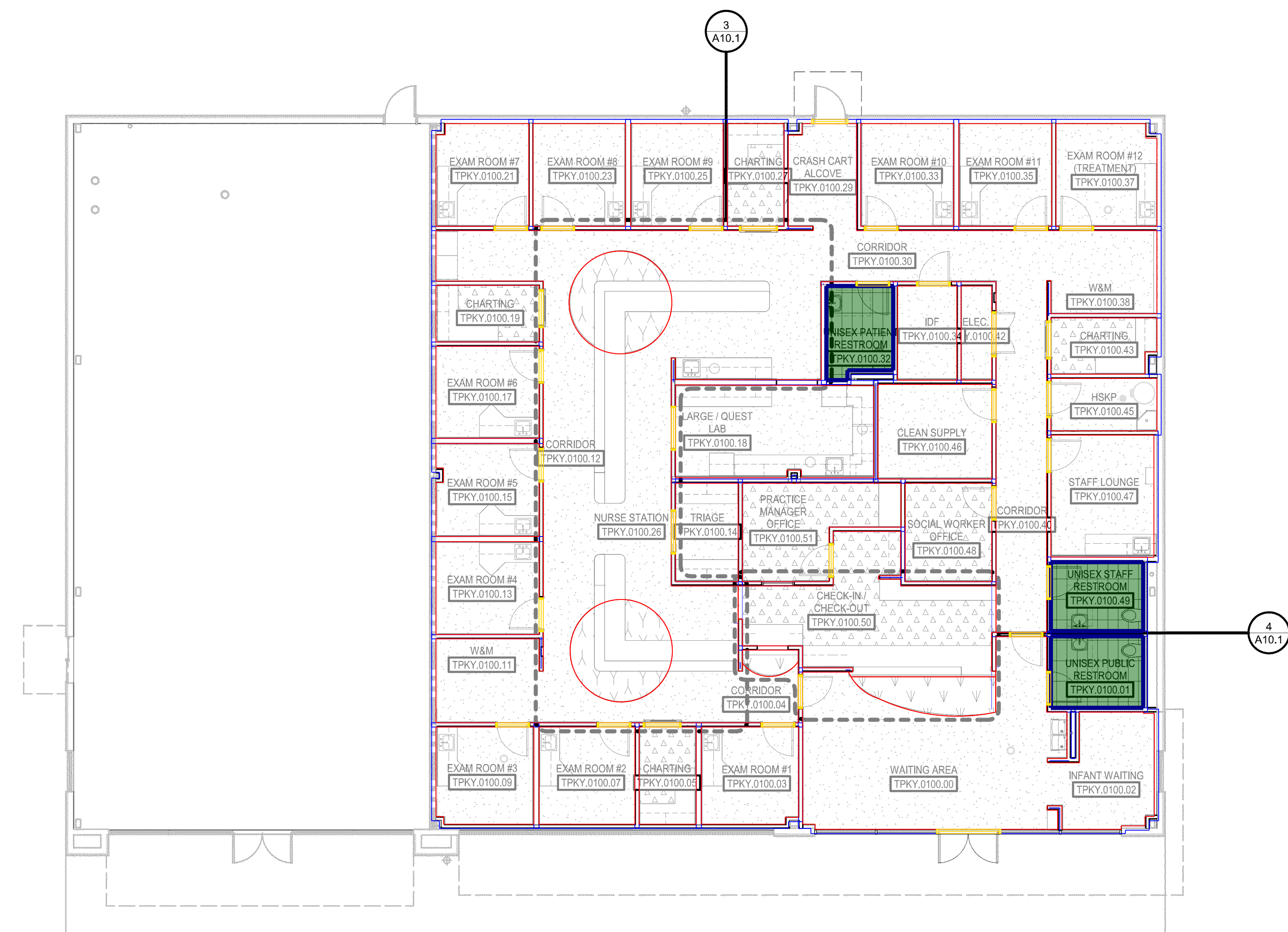

1 FIRST FLOOR FINISH PLAN  
SCALE: 1/8" = 1'-0"

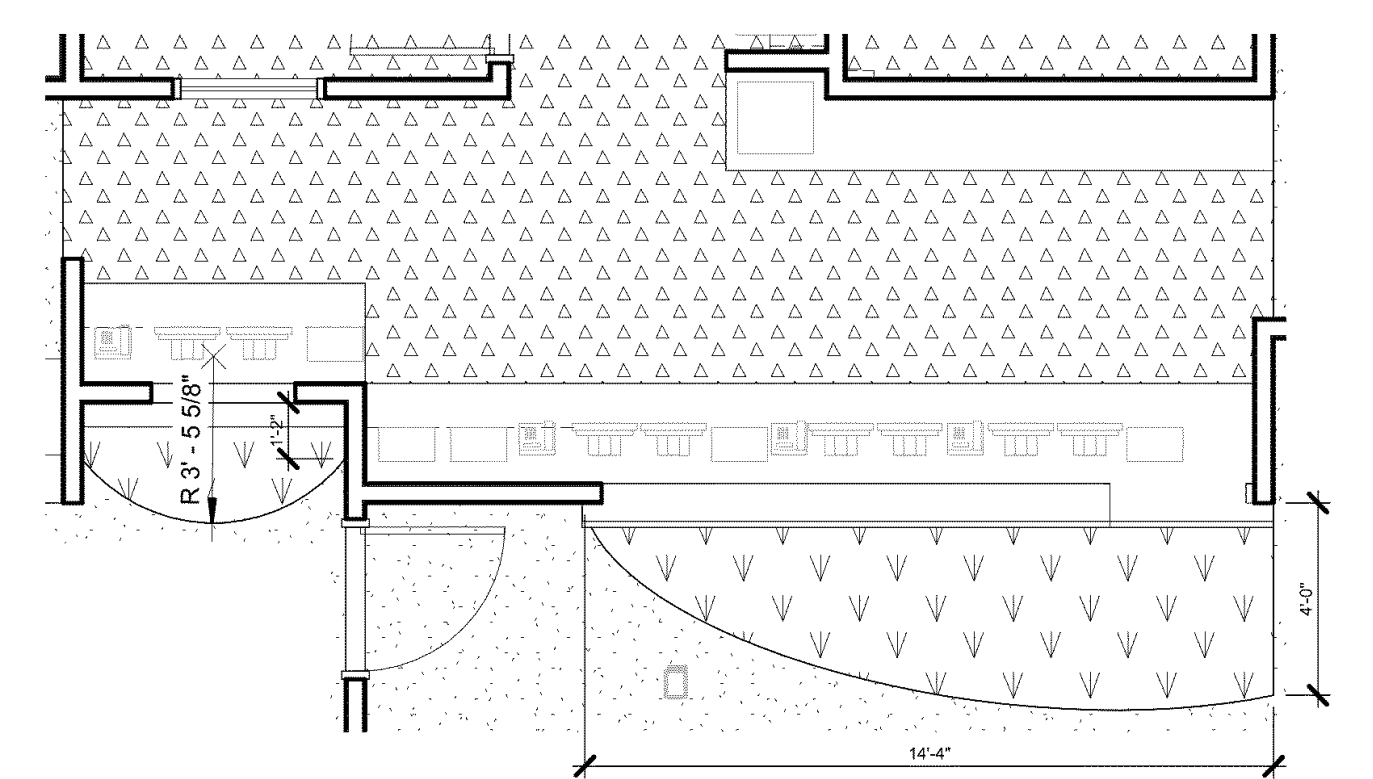

4 CHECK IN / CHECK OUT ENLARGED FINISH PLAN  
SCALE: 1/4" = 1'-0"

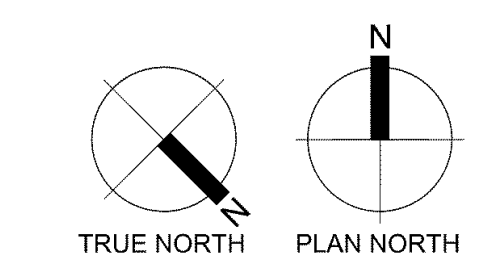



Unisex - TPKY.0100.32

Waterproofing SF

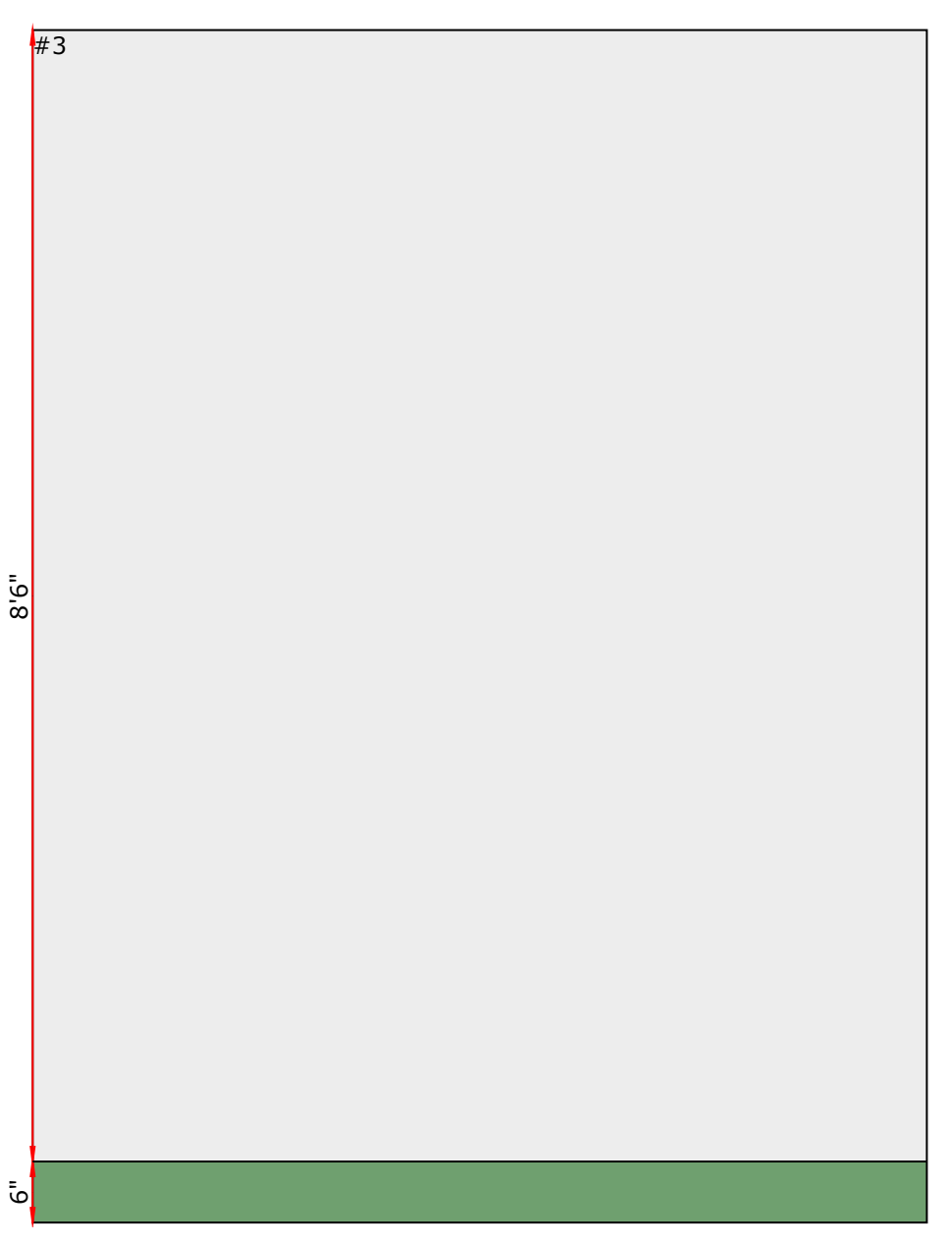
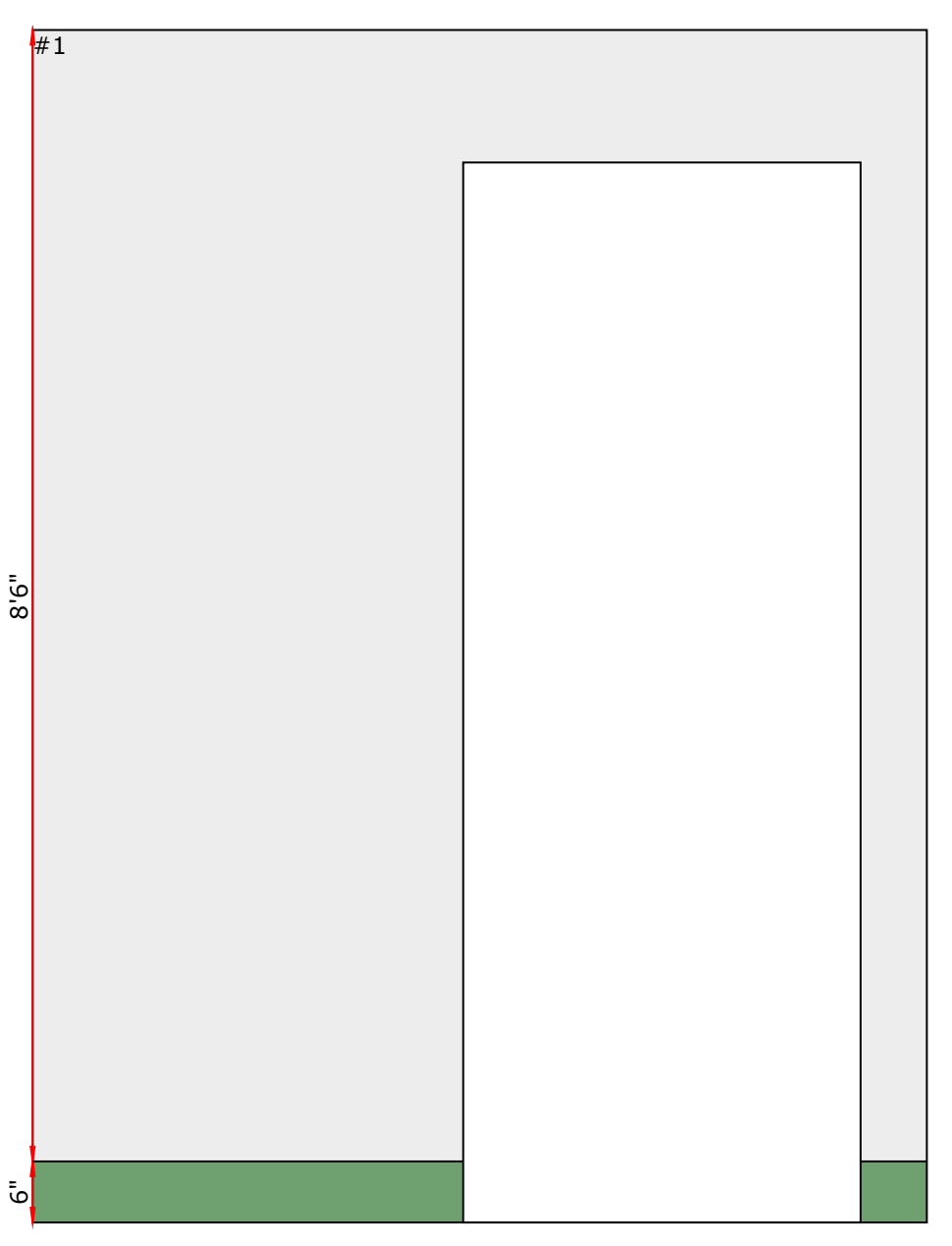
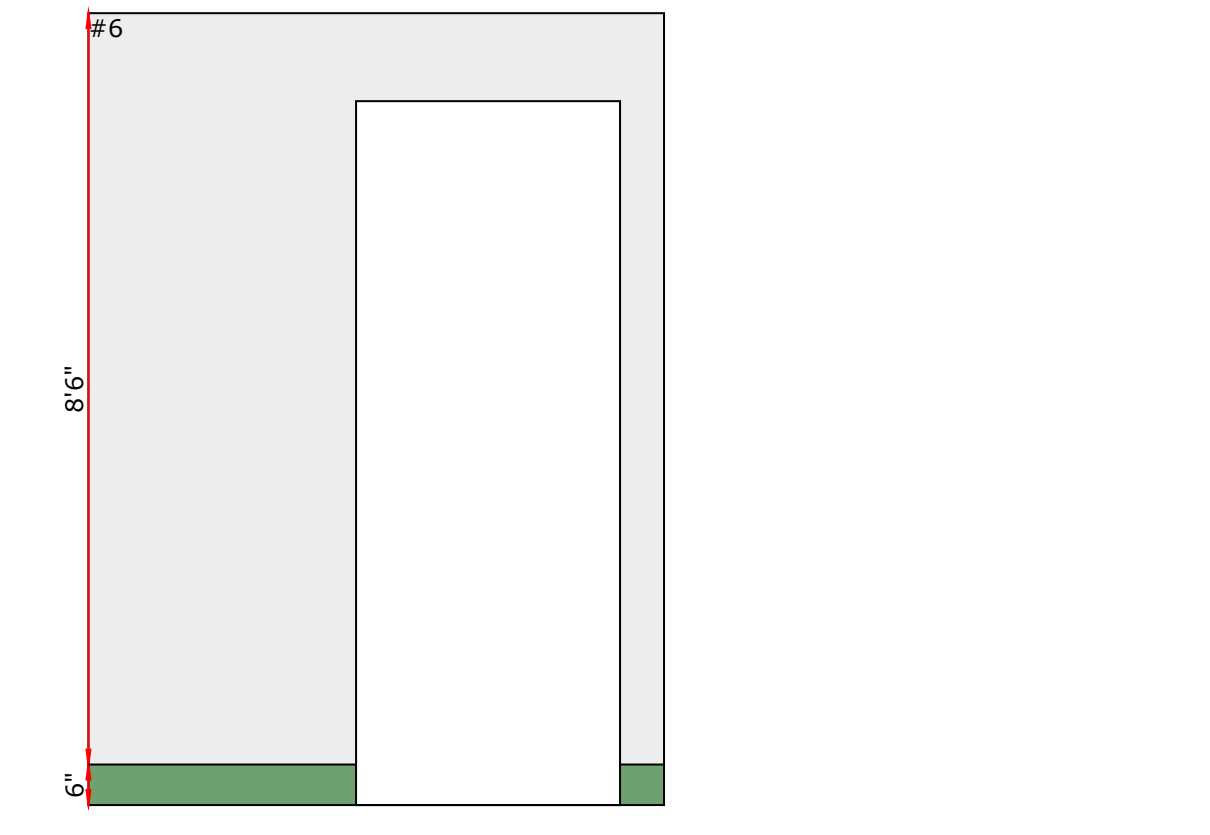
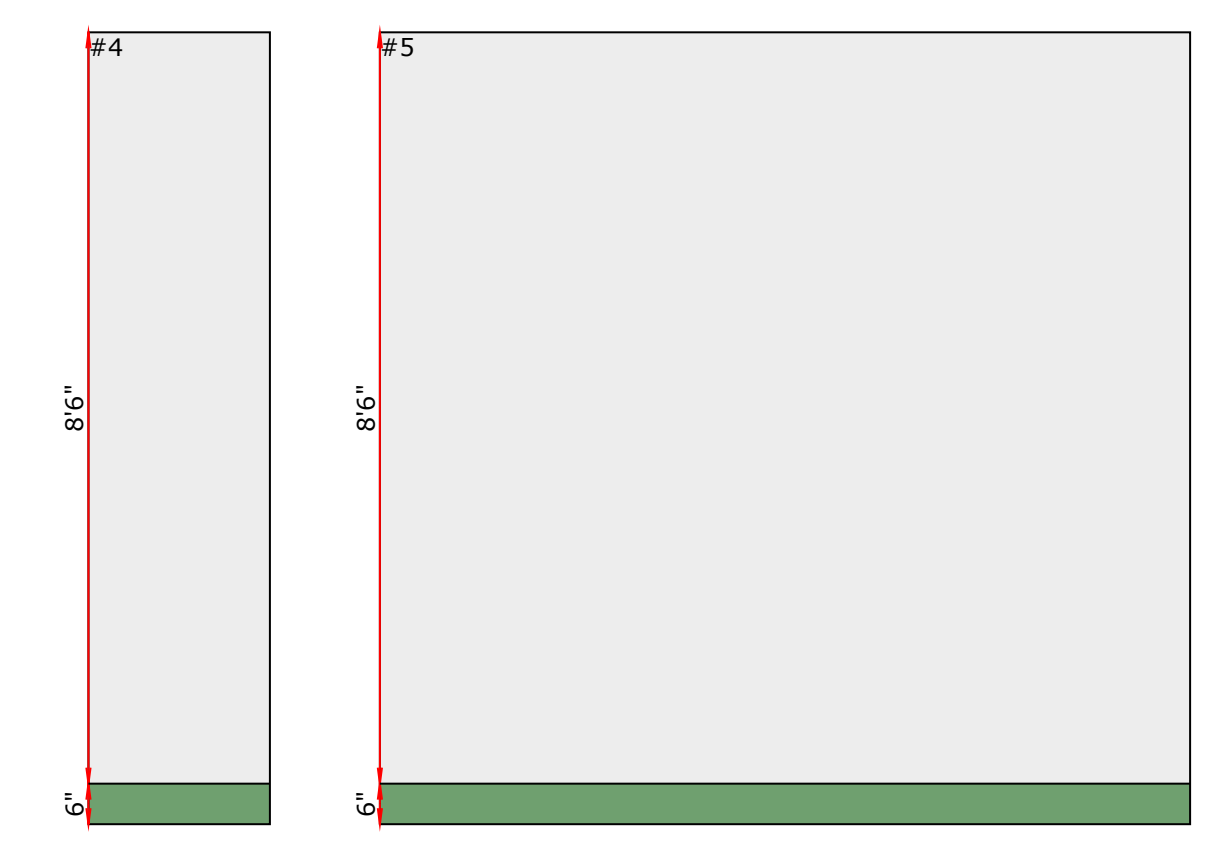
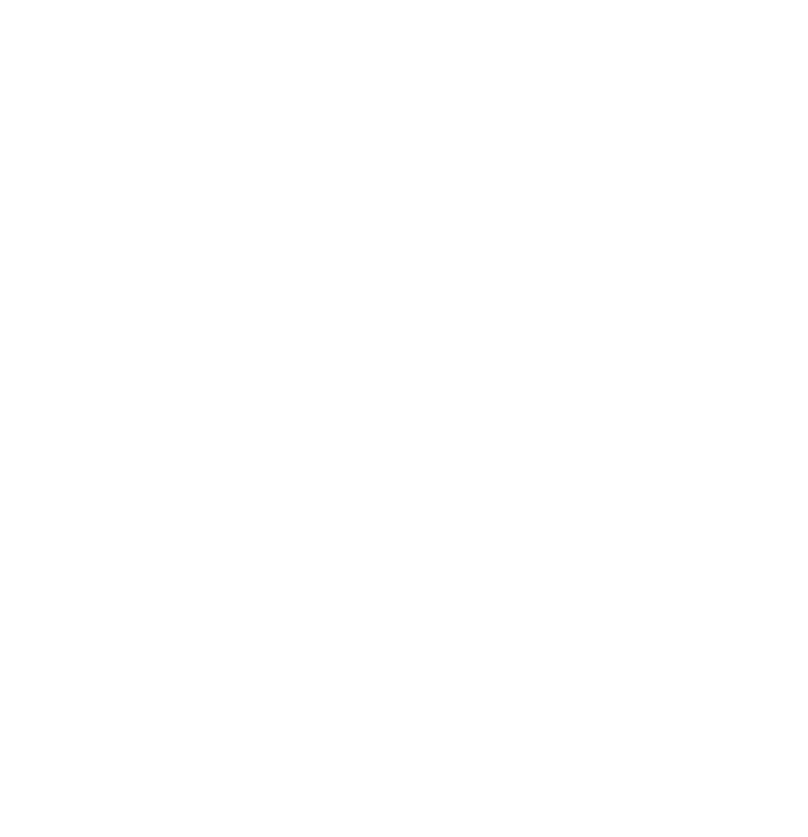
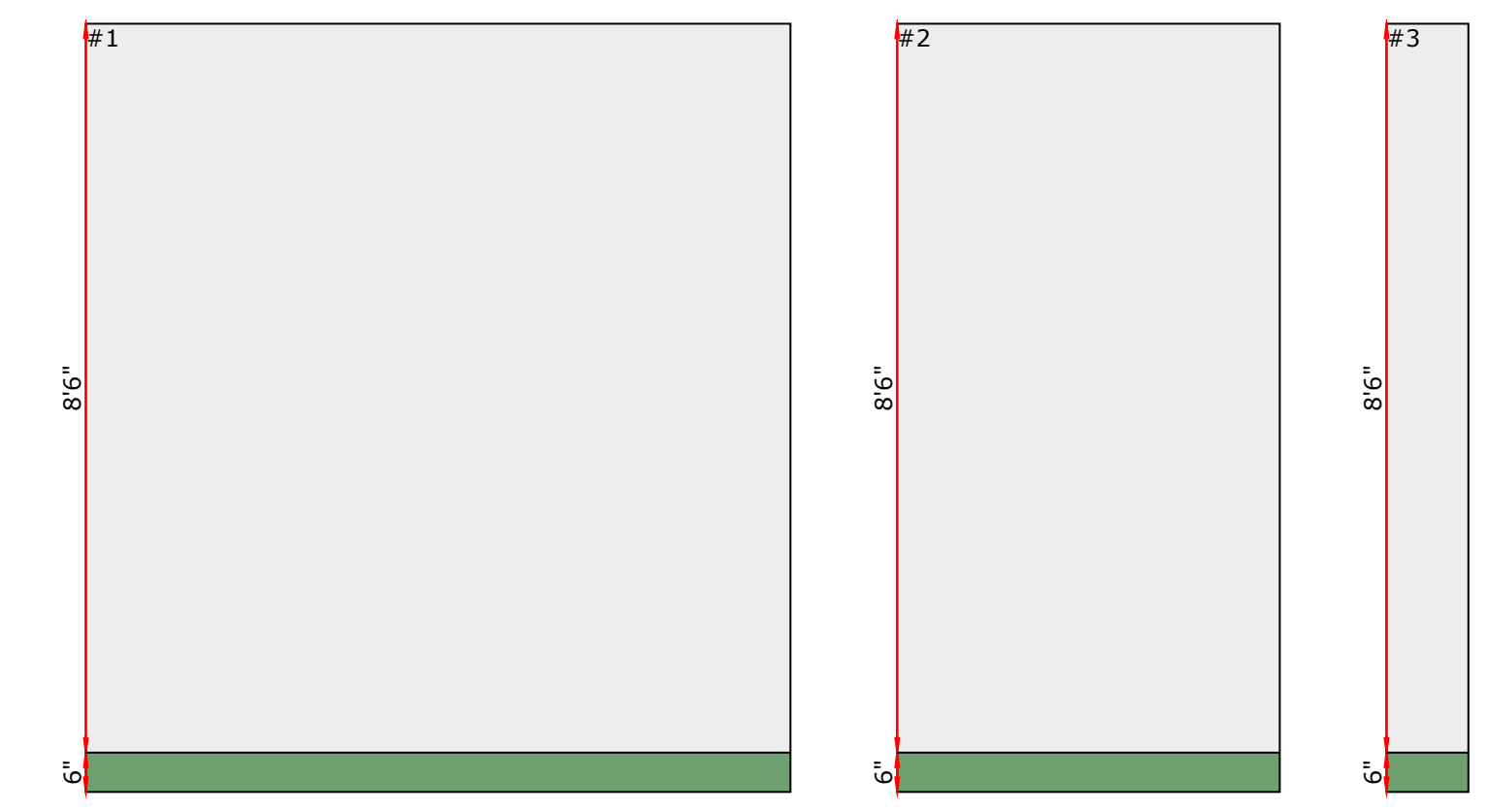
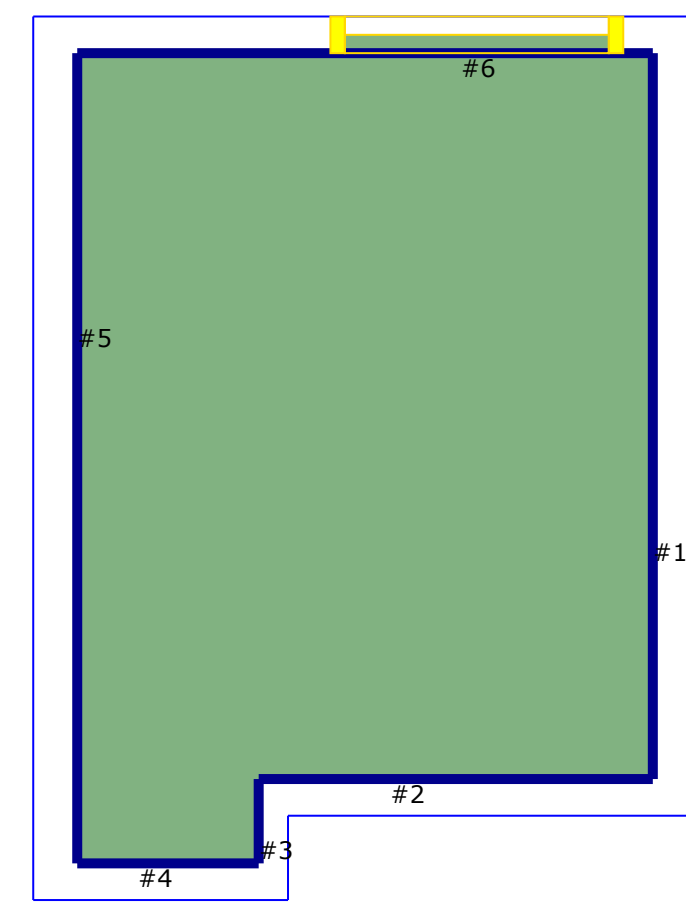

Unisex - TPKY.0100.49

Waterproofing SF

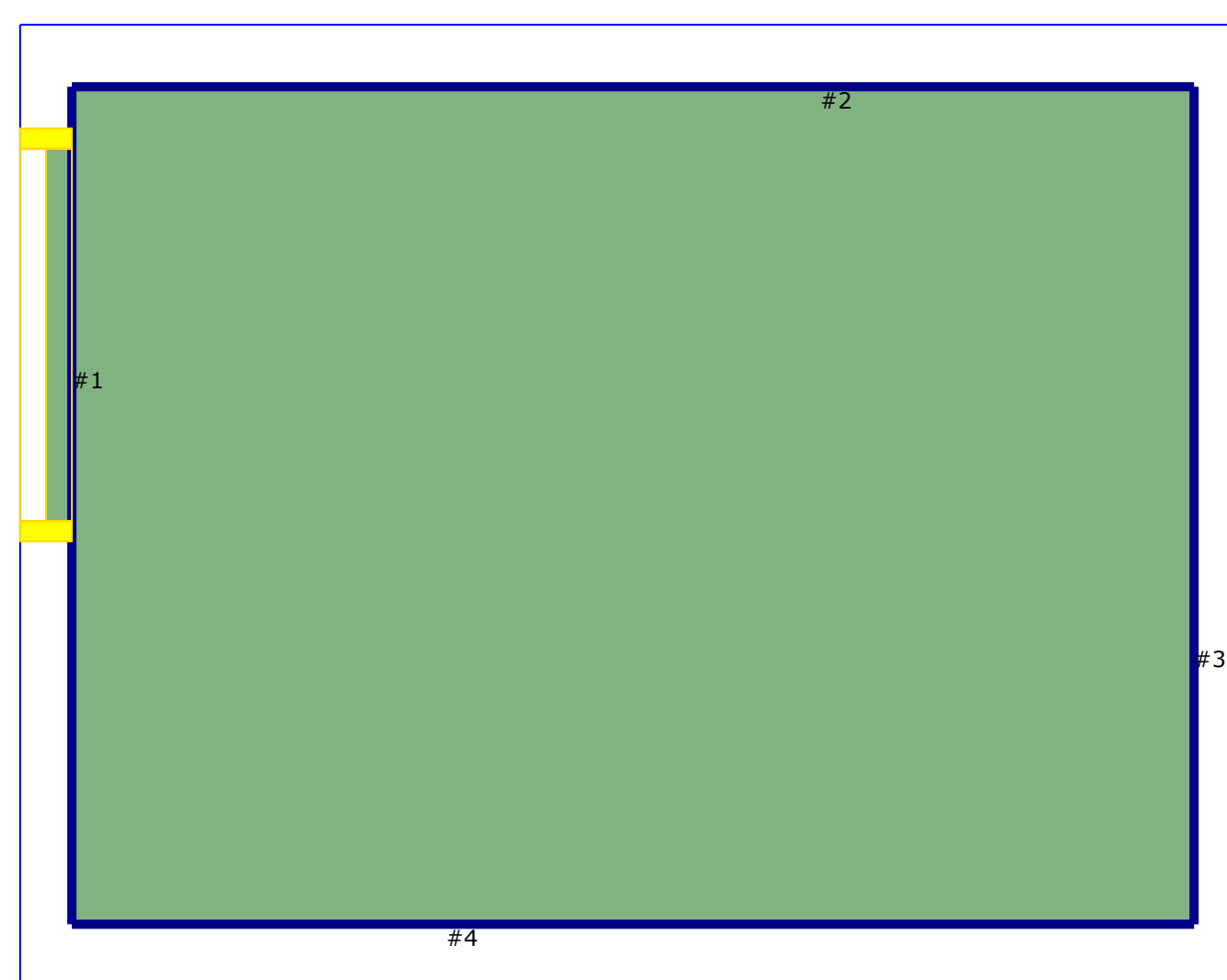

Unisex - TPKY.0100.01

Waterproofing SF

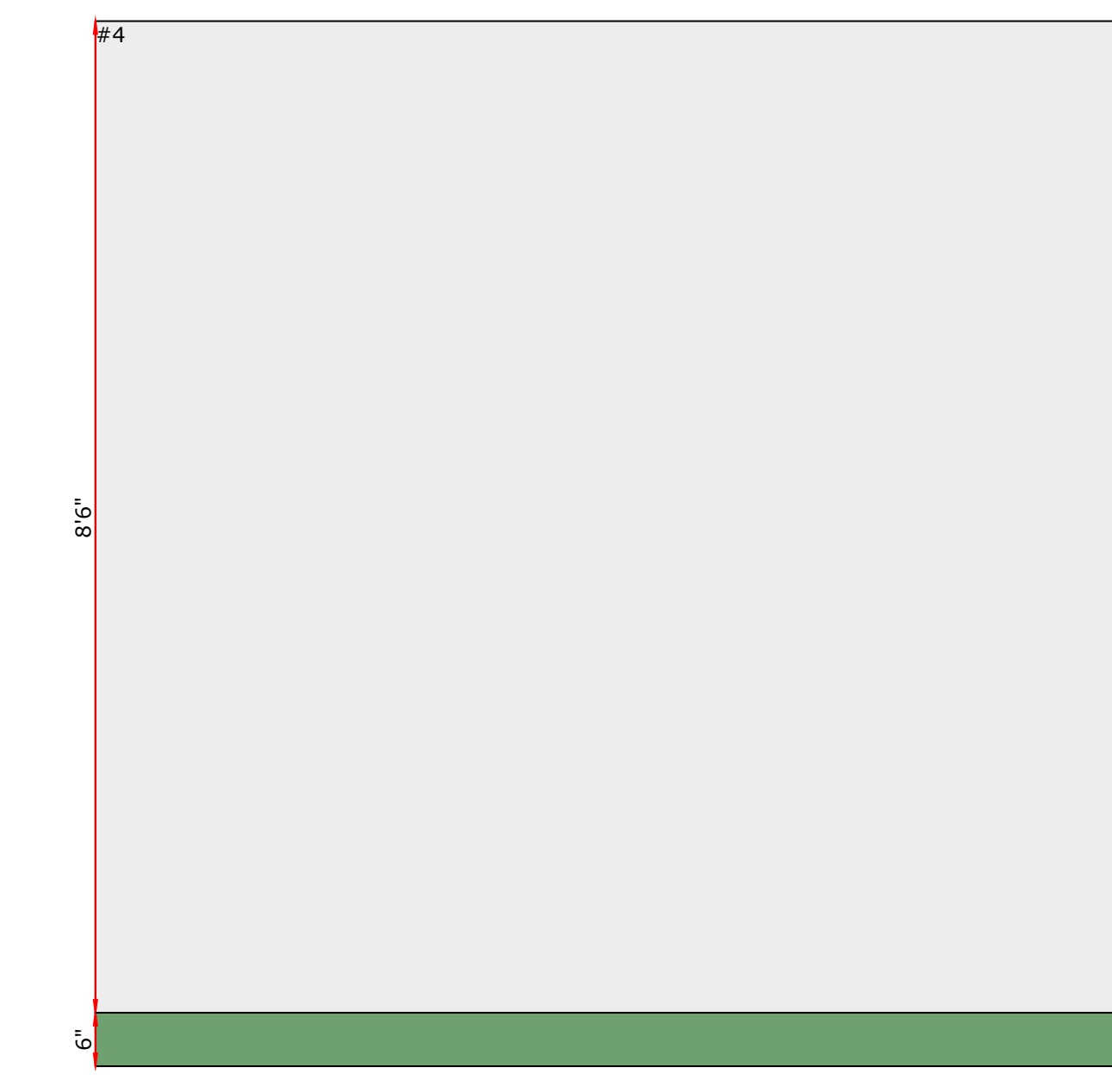
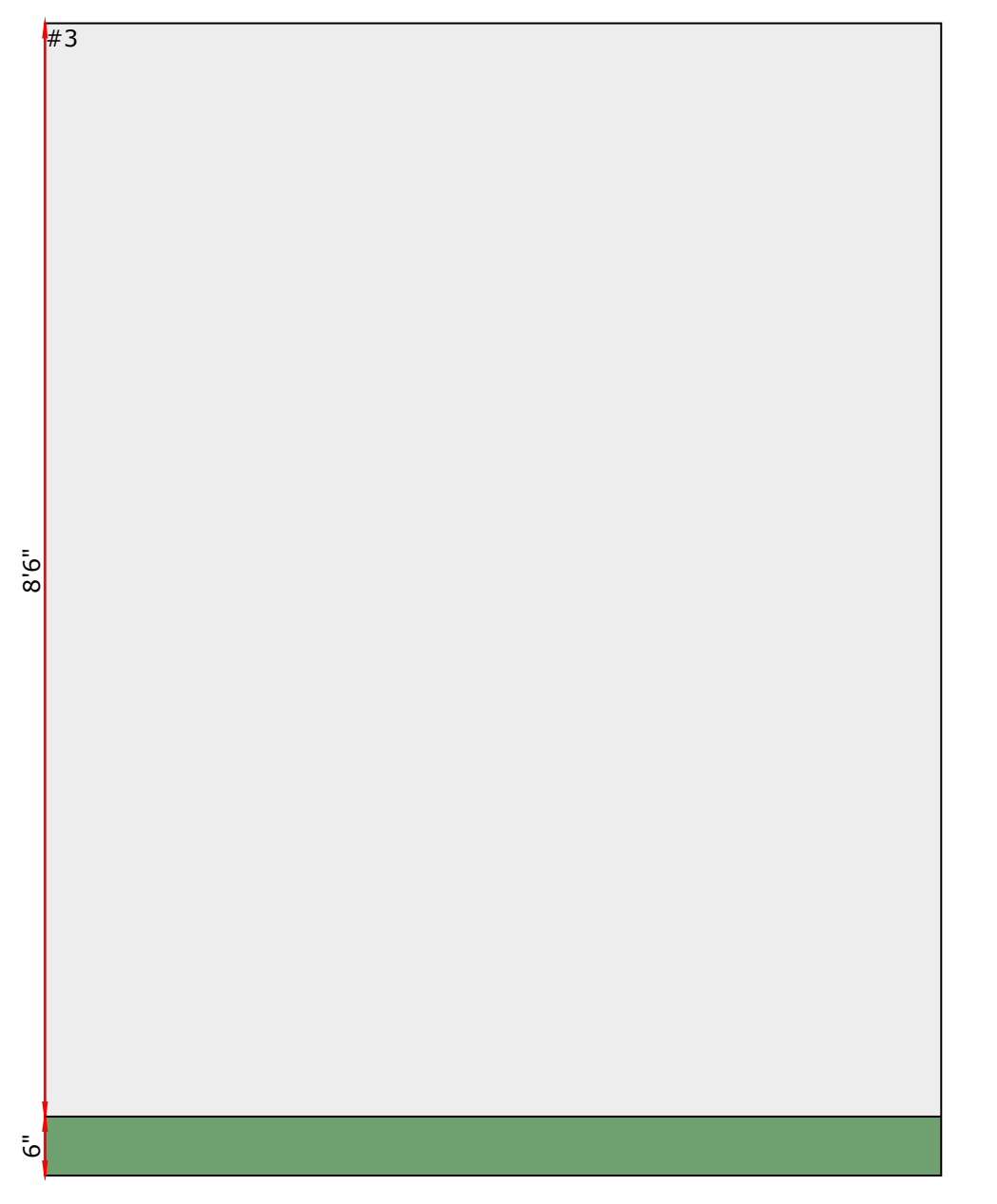
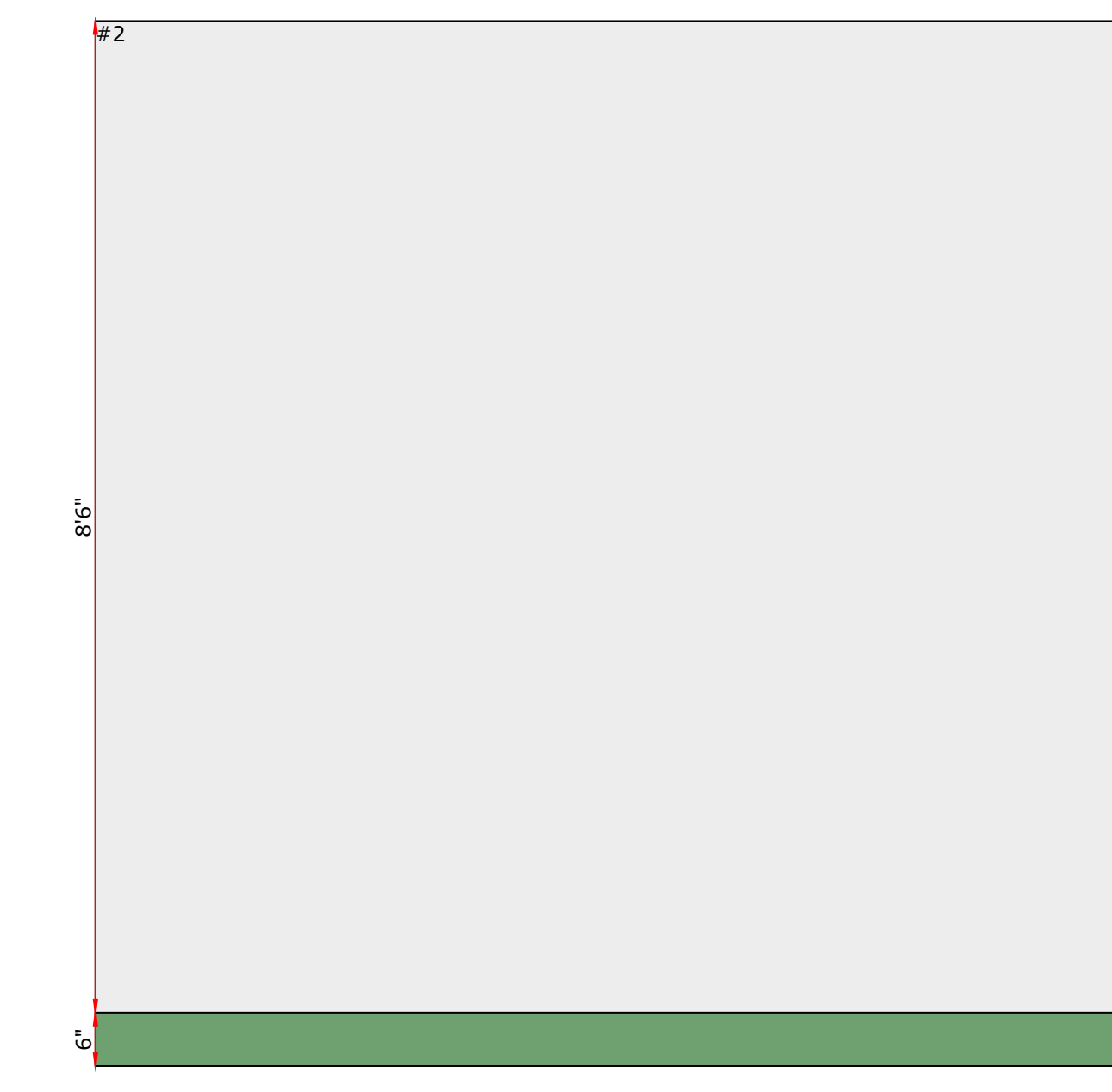
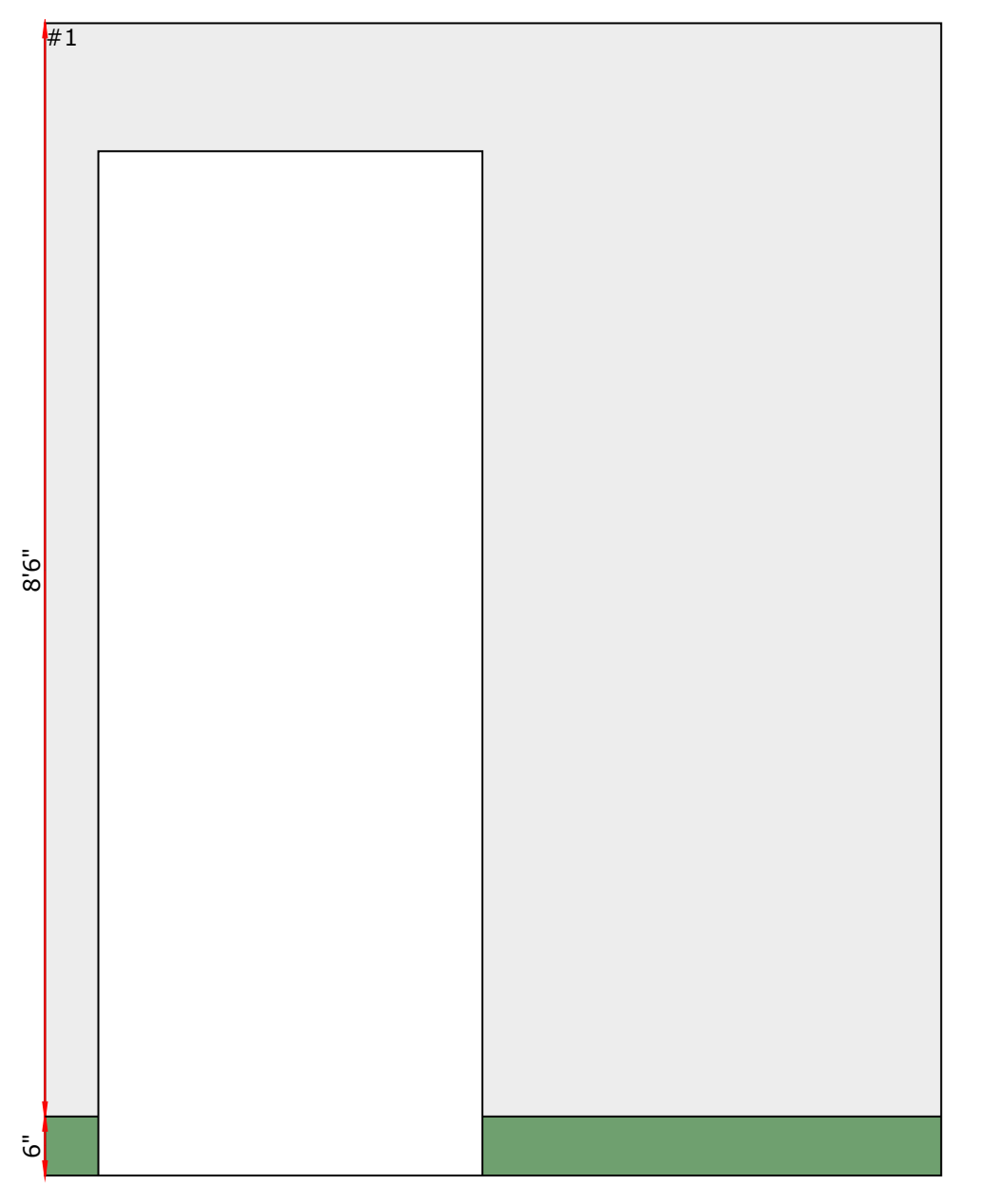
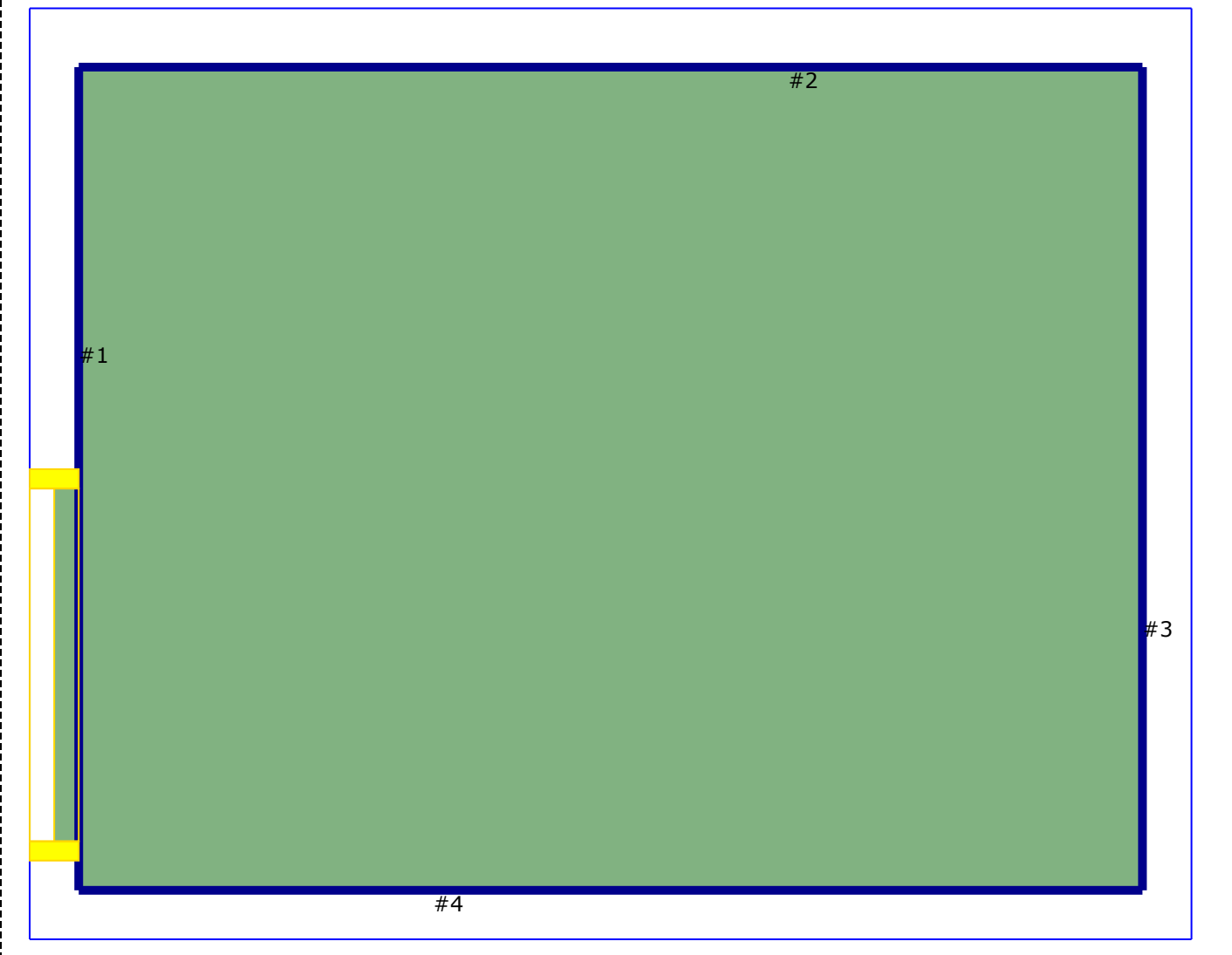

LIST OF FINISHES					
KEY	DESCRIPTION	MANUFACTURER	COLOR/NAME	PATTERN/STYLE	REMARKS
<b>PT - PAINT</b>					
EPT#	EPOXY PAINT	PER SPEC	TO BE DETERMINED	PER SPEC	# INDICATES PT# TO COLOR MATCH
PT1	PAINT - FIELD COLOR	SHERWIN WILLIAMS	PURE WHITE SW-7005	PER SPEC	GENERAL FIELD COLOR
PT2	PAINT	SHERWIN WILLIAMS	PURE WHITE SW-7005	PER SPEC	GYP CEILING U.N.O.
PT3	PAINT	SHERWIN WILLIAMS	COLOR MATCH PANTONE WAYFINDING ORANGE 144U	PER SPEC	GYP CEILING ONLY
PT4	PAINT	SHERWIN WILLIAMS	COLOR MATCH PANTONE TURQUOISE LITE 7457L	PER SPEC	
PT5	PAINT	SHERWIN WILLIAMS	COLOR MATCH PANTONE GREEN BLUE LITE 317U	PER SPEC	
PT6	PAINT	SHERWIN WILLIAMS	COLOR MATCH PANTONE DEEP TEAL 3135U	PER SPEC	GYP CEILING ONLY
PT7	PAINT	SHERWIN WILLIAMS	COLOR MATCH PANTONE PURPLE TINT 7404U	PER SPEC	
<b>PL - PLASTIC LAMINATE</b>					
PL1	LAMINATE SHEET	WILSONART	FUSION MAPLE 7909-60	TO BE DETERMINED	VERTICAL SURFACES
PL2	LAMINATE SHEET	WILSONART	AMBER CHERRY 7919-38	TO BE DETERMINED	COUNTERTOPS AND UPPER CABINETS: PHYSICIAN BULLPEN ONLY
PL3	LAMINATE SHEET	FORMICA	WHITE DROPS 8824-58	TO BE DETERMINED	COUNTERTOPS U.N.O.
<b>BASE</b>					
RB1	RUBBER BASE	ROPPE	P175 SLATE	PER SPEC	
<b>T - TILE</b>					
T1	12"x24" PORCELAIN TILE	TRINITY TILE	WHITE SHADES	SOCIAL COLLECTION	HORIZONTAL INSTALLATION. GROUT BOD: LATICRETE 18 SAUTERNE
T2	12"x24" PORCELAIN TILE	TRINITY TILE	BALANCE GREY	SOCIAL COLLECTION	TOILET WALL AND FLOOR ONLY. GROUT BOD: LATICRETE 18 SAUTERNE
T3	3"x6" GLASS TILE	DALTILE	RUSSET ORANGE CW29	COLOR WAVE	TILE BAND ON NON-WET WALLS. GROUT BOD: LATICRETE 18 SAUTERNE
T4	3"x6" GLASS TILE	DALTILE	PURPLE MAGIC CW31	COLOR WAVE	TILE BAND ON NON-WET WALLS. GROUT BOD: LATICRETE 18 SAUTERNE
T5	3"x6" GLASS TILE	DALTILE	CAPRI BREEZE CW32	COLOR WAVE	TILE BAND ON NON-WET WALLS. GROUT BOD: LATICRETE 18 SAUTERNE
<b>CPT - CARPET</b>					
CPT1	CARPET TILE	J&J COMMERCIAL	TELL A TALE 1811	IMPULSE III	INSTALL PER MANUFACTURER SPEC.
<b>RF - RESILIENT FLOOR</b>					
RF1	HOMOGENEOUS VINYL SHEET	TARKETT	CARAMEL C117	COLOR PLAY - COLOR BEAM	INSTALL PER MANUFACTURER SPEC.
RF2	HOMOGENEOUS VINYL SHEET	TARKETT	CERULEAN C103	COLOR PLAY - COLOR BEAM	INSTALL PER MANUFACTURER SPEC.
RF3	HOMOGENEOUS VINYL SHEET	TARKETT	GOLDENROD C107	COLOR PLAY - COLOR BEAM	INSTALL PER MANUFACTURER SPEC.
<b>SS - SOLID SURFACE</b>					
SS1	1/2" SOLID SURFACE	FORMICA	505 SEA GLASS	SATIN WITH EASED EDGE	CHECK-IN/CHECK-OUT COUNTERS ONLY
SS2	1/2" SOLID SURFACE	FORMICA	931 WHITE SPEX	SATIN WITH EASED EDGE	WET AREAS ONLY
<b>CONCRETE FLOOR CONDITIONS</b>					
CONC1	EXPOSED CONCRETE FLOORS AND CURBS FOR HVAC ROOMS	TO BE DETERMINED	TO BE DETERMINED	PER SPEC	
SC	SEALED CONCRETE	TO BE DETERMINED	TO BE DETERMINED	PER SPEC	
<b>WP - WALL PROTECTION</b>					
WIP	WALL PROTECTION	CS ACROVYN	#949 WHITE	PER SPEC	
<b>ACT - ACOUSTICAL CEILING TILE</b>					
ACT1	2'X2' LAY IN CEILING TILE	CERTAINTeed	WHITE	FINE FISSURED	
<b>W - WINDOWS</b>					
W-T	WINDOW - TREATMENT				

FINISH PATTERNS

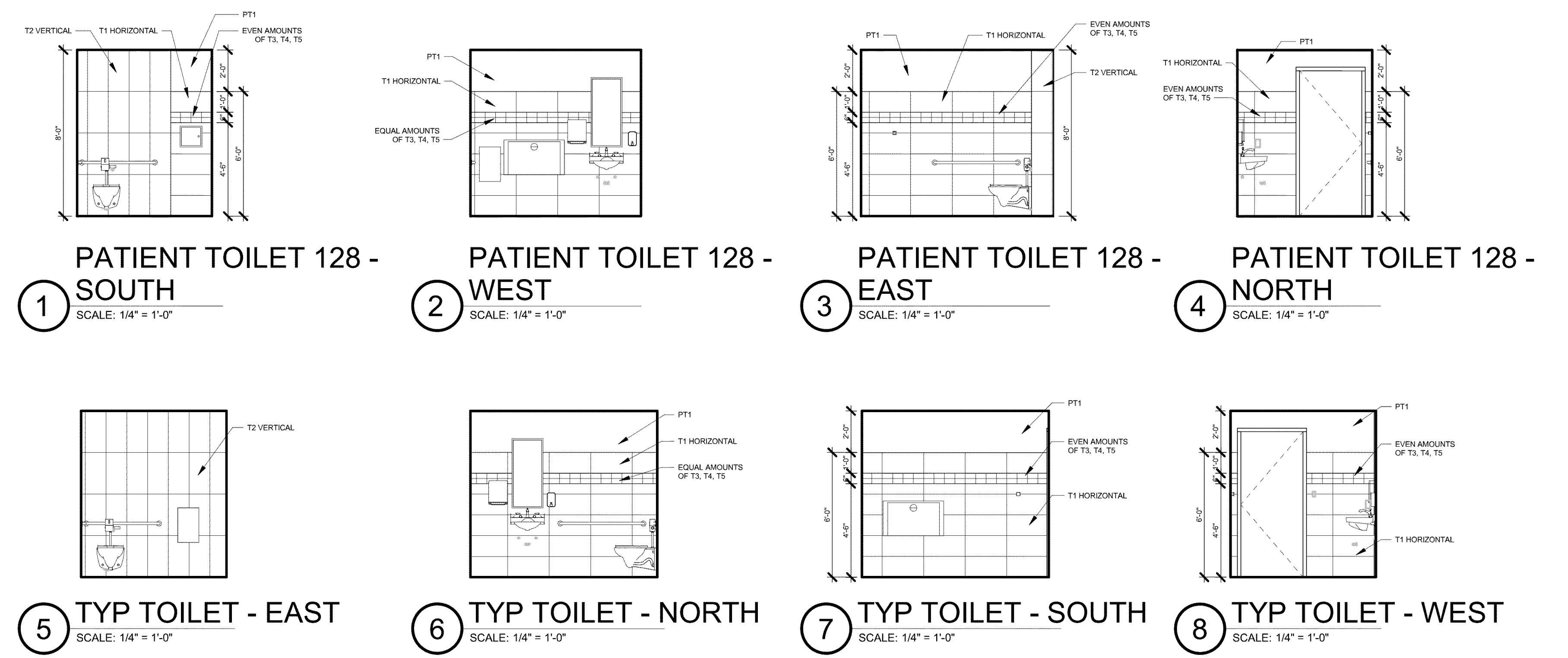

FINISH TRANSITIONS

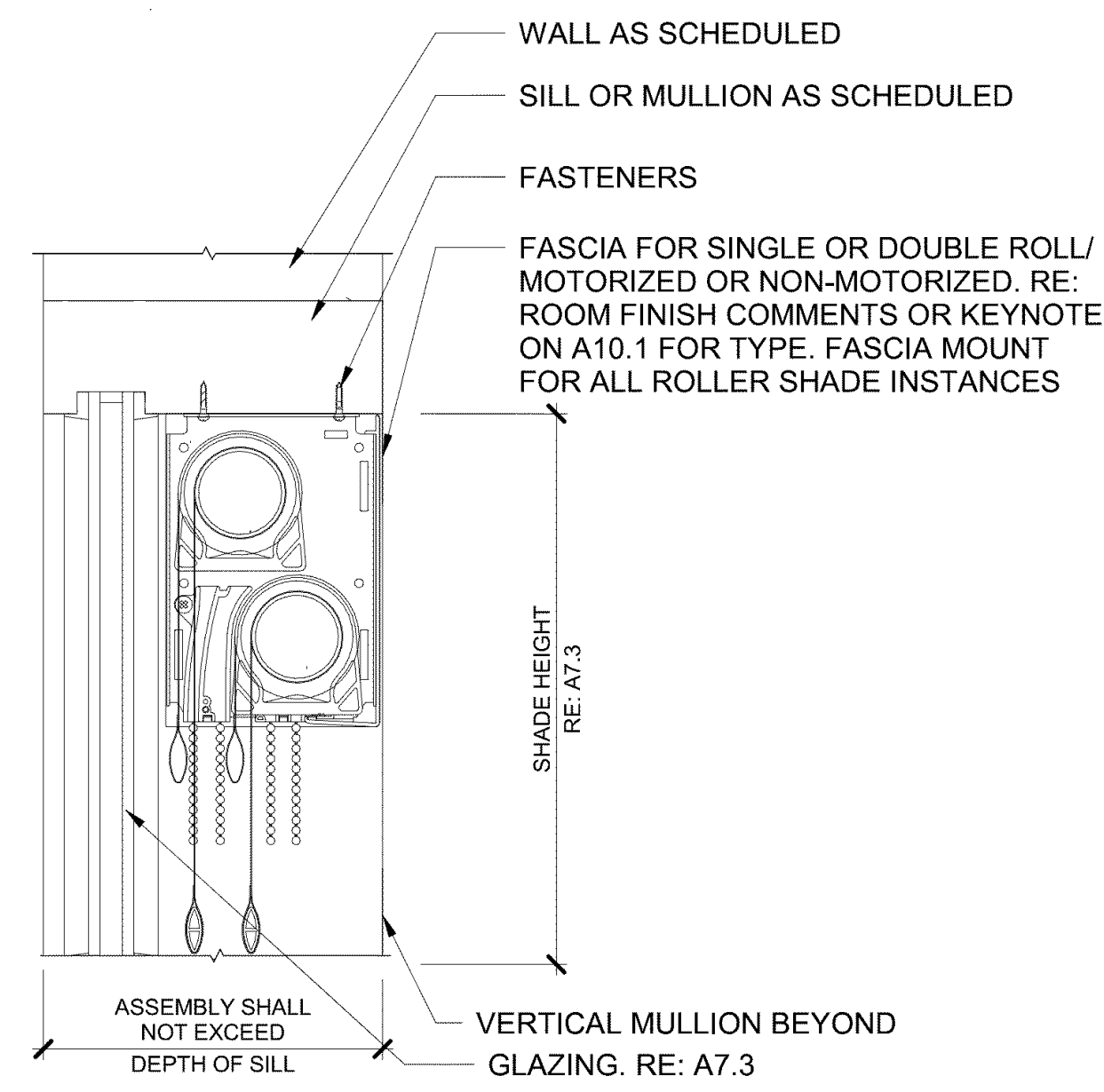

TYP. ROLLER SHADE DETAIL

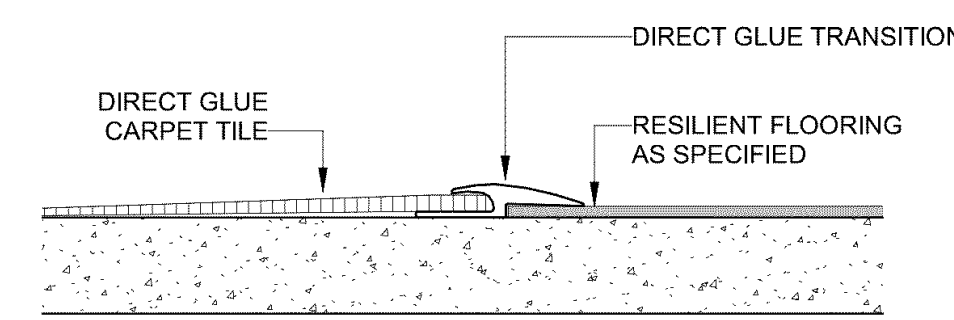

FLOORING TRANSITION - RESILIENT FLOORING TO CARPET

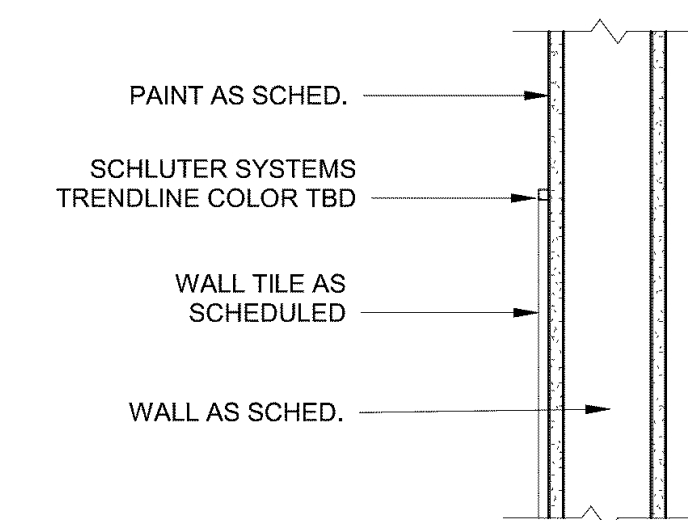

TOP OF TILE DETAIL

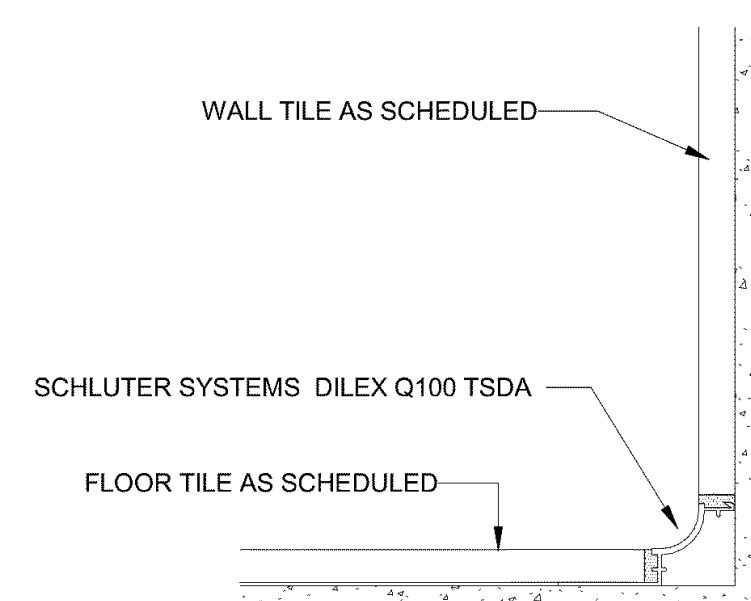

BASE TRANSITION - TILE FLOOR TO TILE WALL

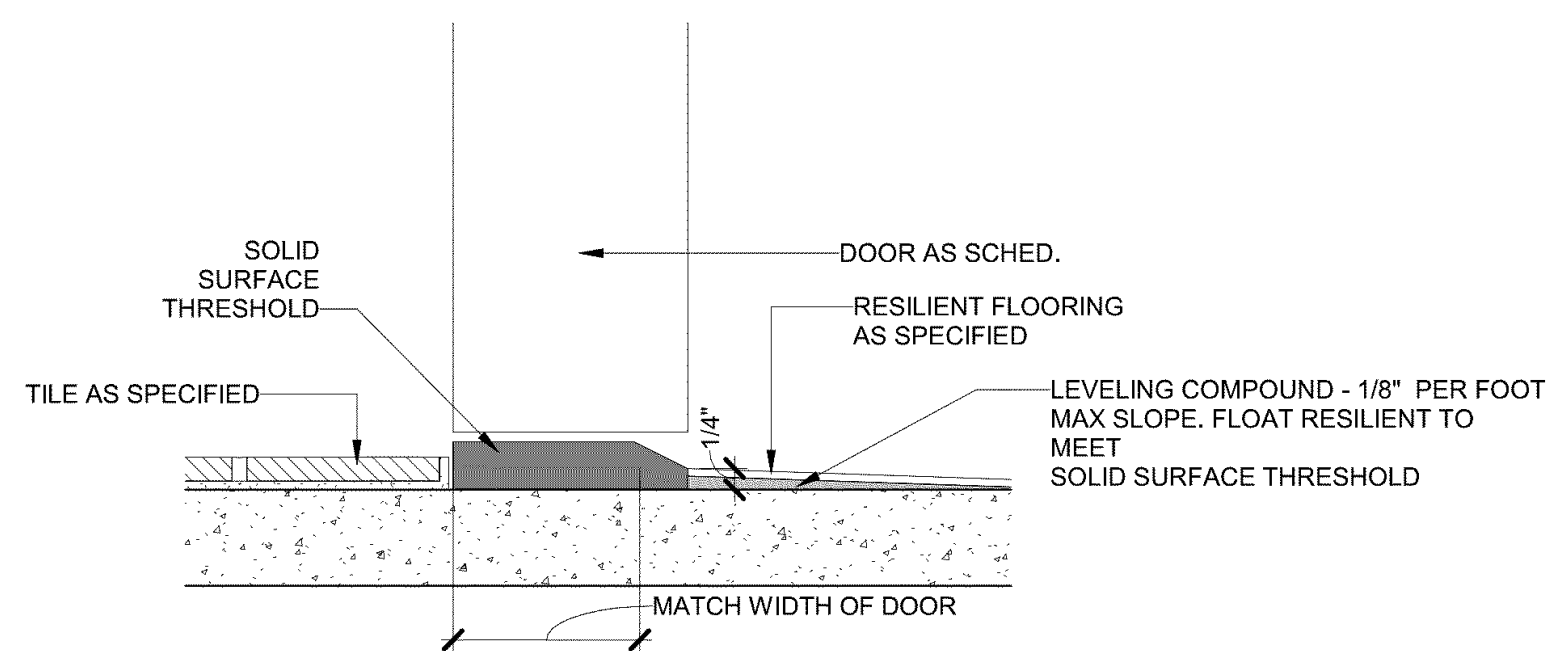

FLOORING TRANSITION - SOLID SURFACE THRESHOLD

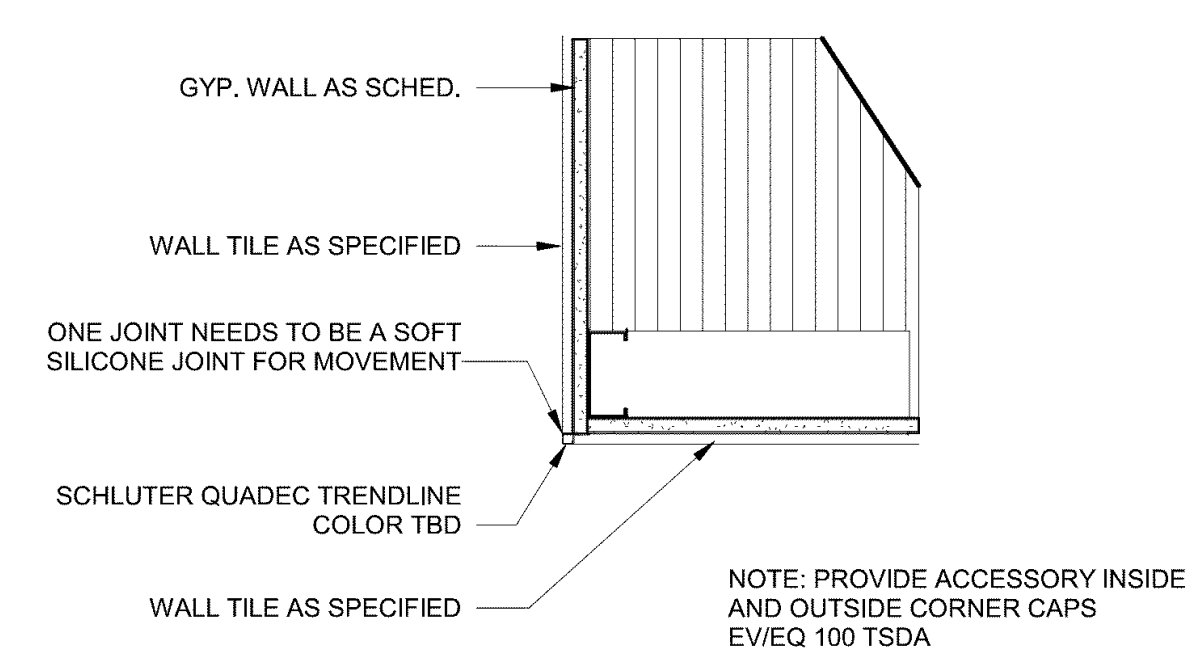

OUTSIDE TILE CORNER DETAIL



Detail for Outside Corner calls for TBD Color and also notes TSDA - Dark Anthracite color. See Page A.10.

Confirm Dilex spec - Q 100 TSDA does not exist for that material.

Confirm spec for RF1 - RF3. Finish Schedule calls for roll good, but the manufacturer site doesn't list that as an option. See below:

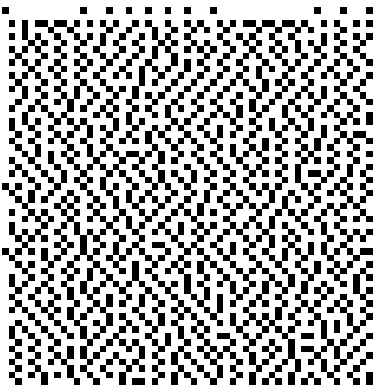
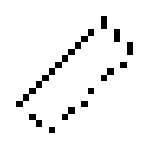
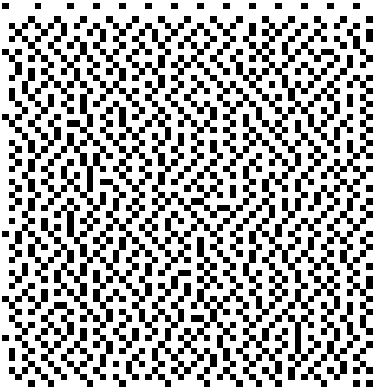
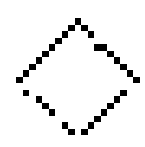
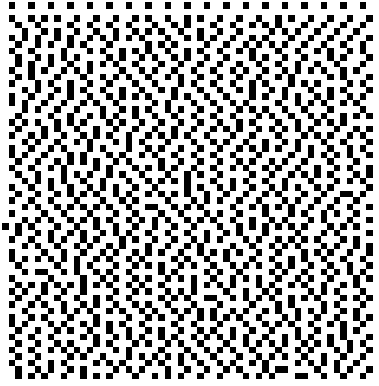
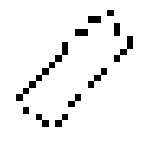
Design	Format & Size	Surface Type	Wear layer thickness	Installation	Packaging
 Color Beam GOLDENROD C107 Ref. 251105046	 Plank 6" x 36" Square Edges	Texture	32 mil (0.81 mm)	Glue-Down	24 planks per box 36 sq. ft per box
 Color Beam GOLDENROD C107 Ref. 251100079	 Tile 18" x 18" Square Edges	Texture	32 mil (0.81 mm)	Glue-Down	20 tiles per box 45 sq. ft per box 60 boxes per pallet
 Color Beam GOLDENROD C107 Ref. 251108087	 Plank 9" x 36" Square Edges	Texture	32 mil (0.81 mm)	Glue-Down	20 planks per box 45 sq. ft per box